

Electrical Schematic, Lower Controls, Perkins Engine

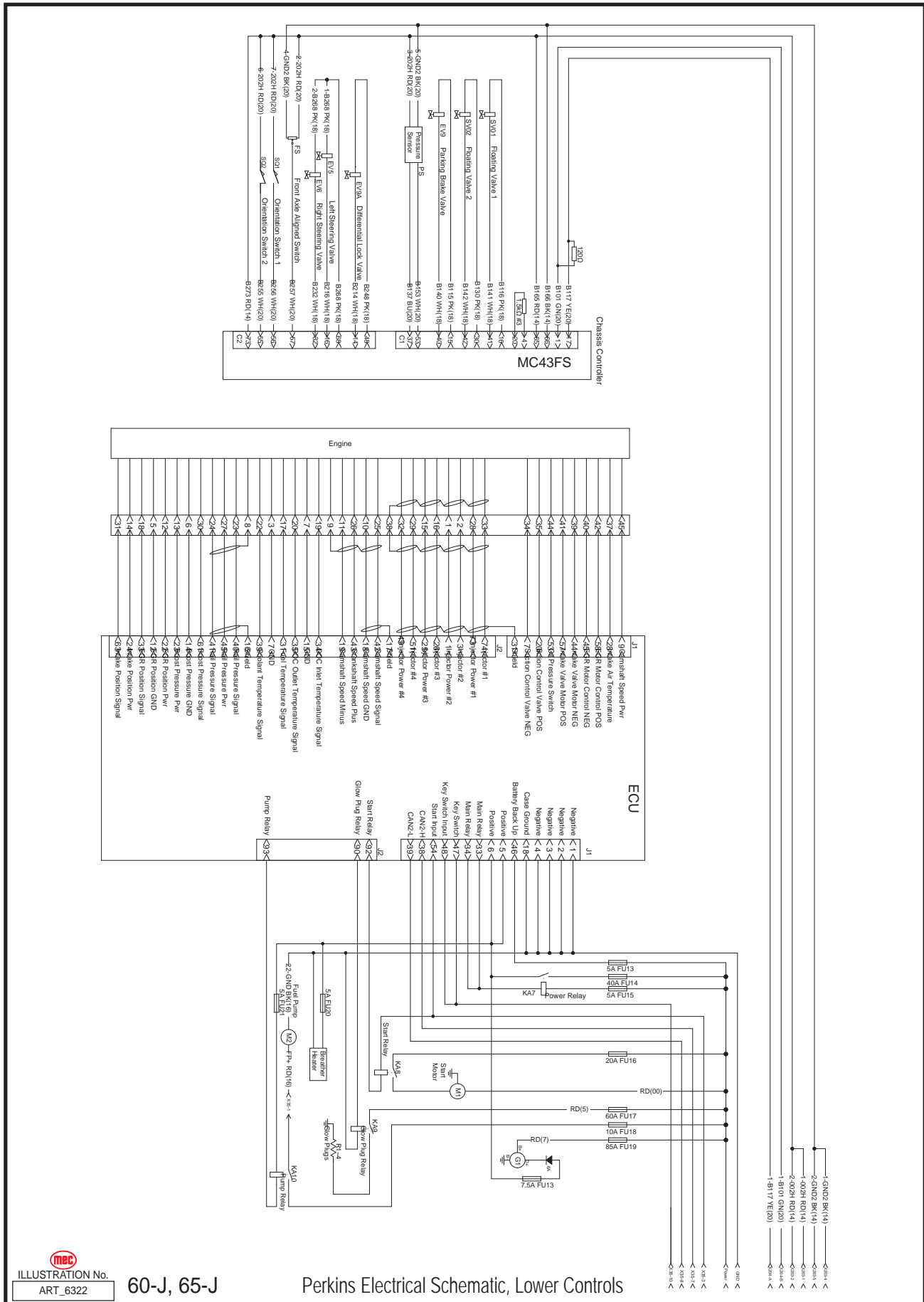

ILLUSTRATION No. ART_6322

60-J, 65-J

Perkins Electrical Schematic, Lower Controls



Electrical Schematic, Chassis, Perkins Engine

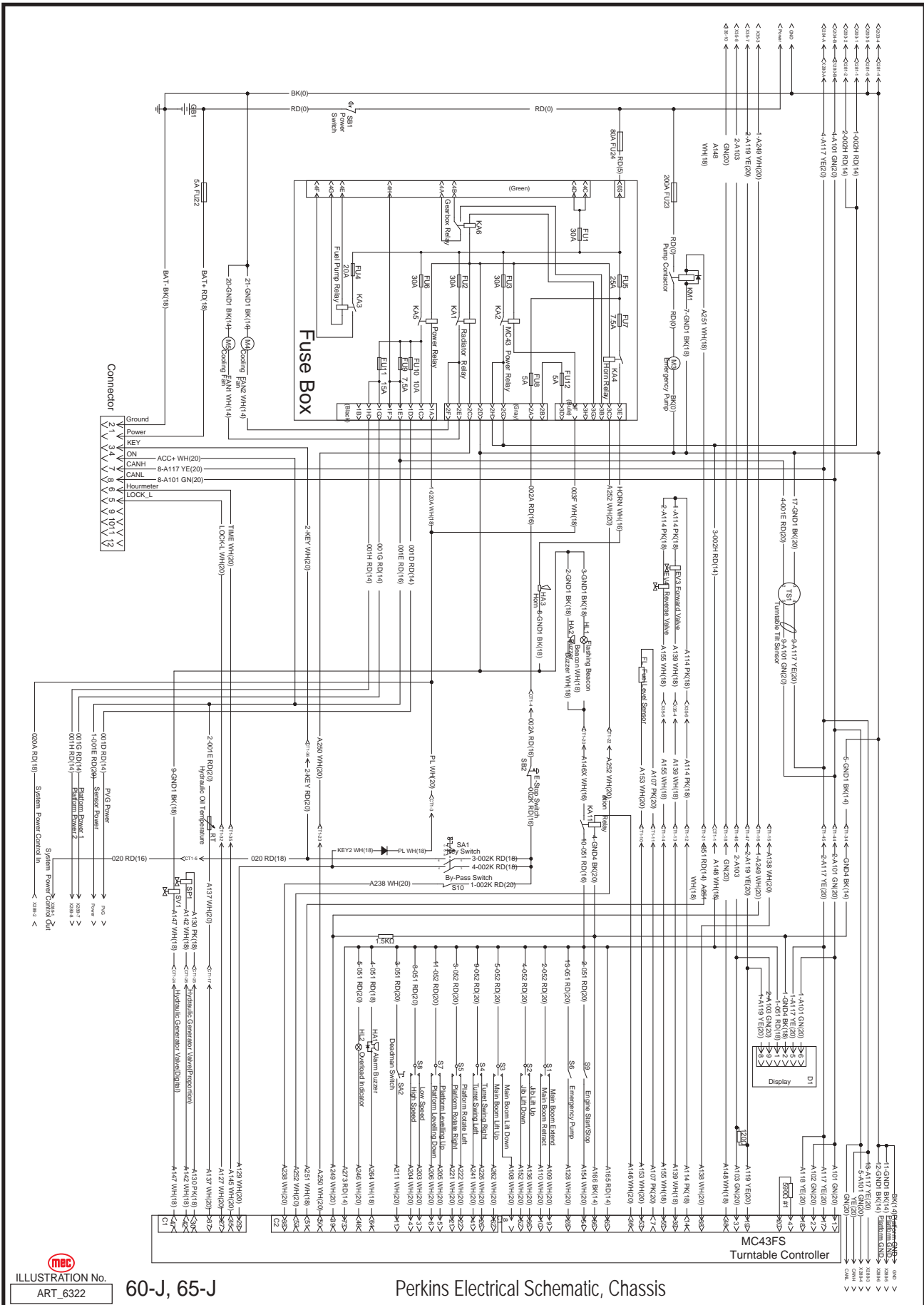

ILLUSTRATION No. ART_6322

60-J, 65-J

Perkins Electrical Schematic, Chassis



Electrical Schematic, Upper Controls, Perkins Engine

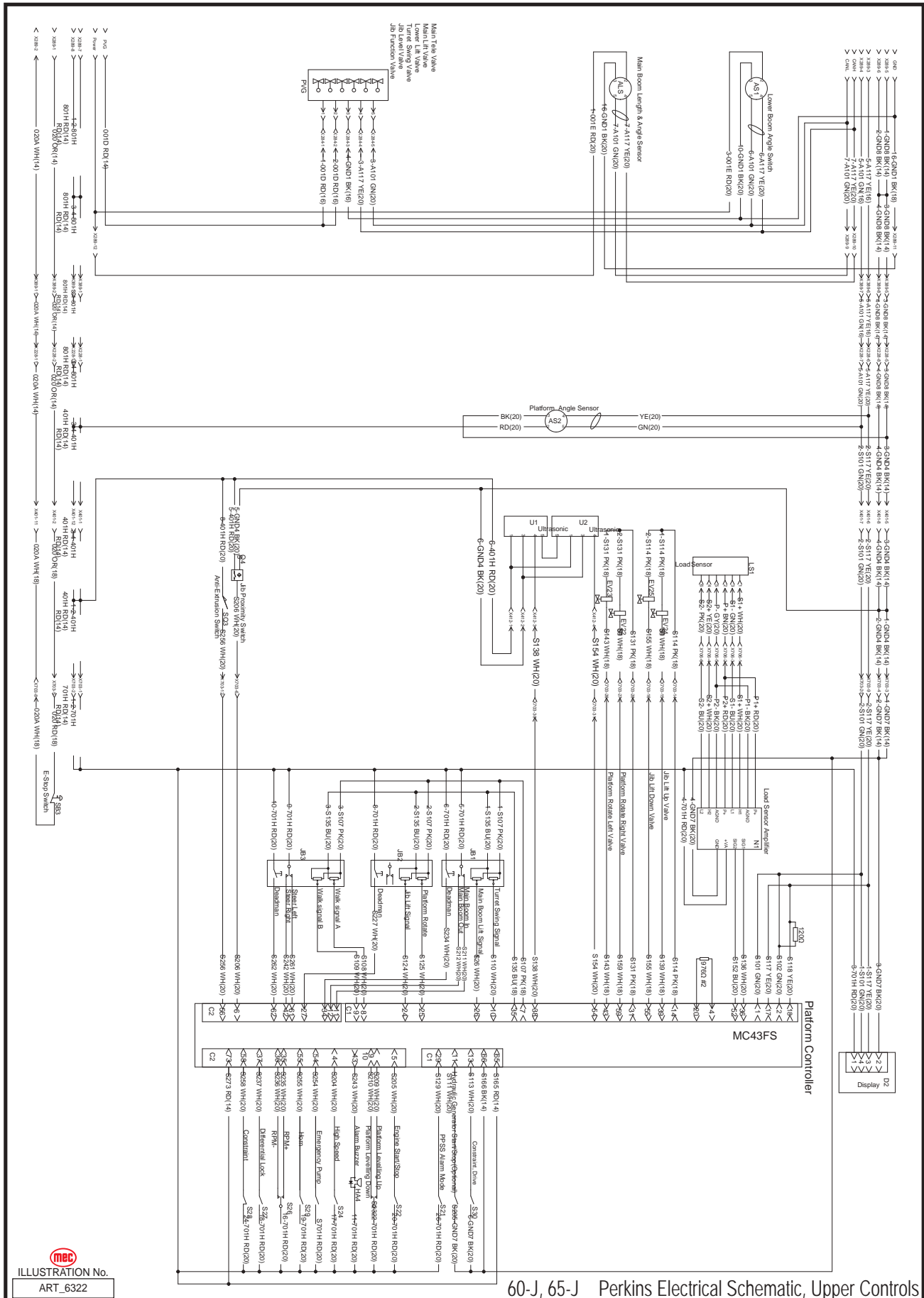

60-J, 65-J Perkins Electrical Schematic, Upper Controls

ILLUSTRATION No. ART_6322



Electrical Schematic, Lower Controls, Kubota Engine

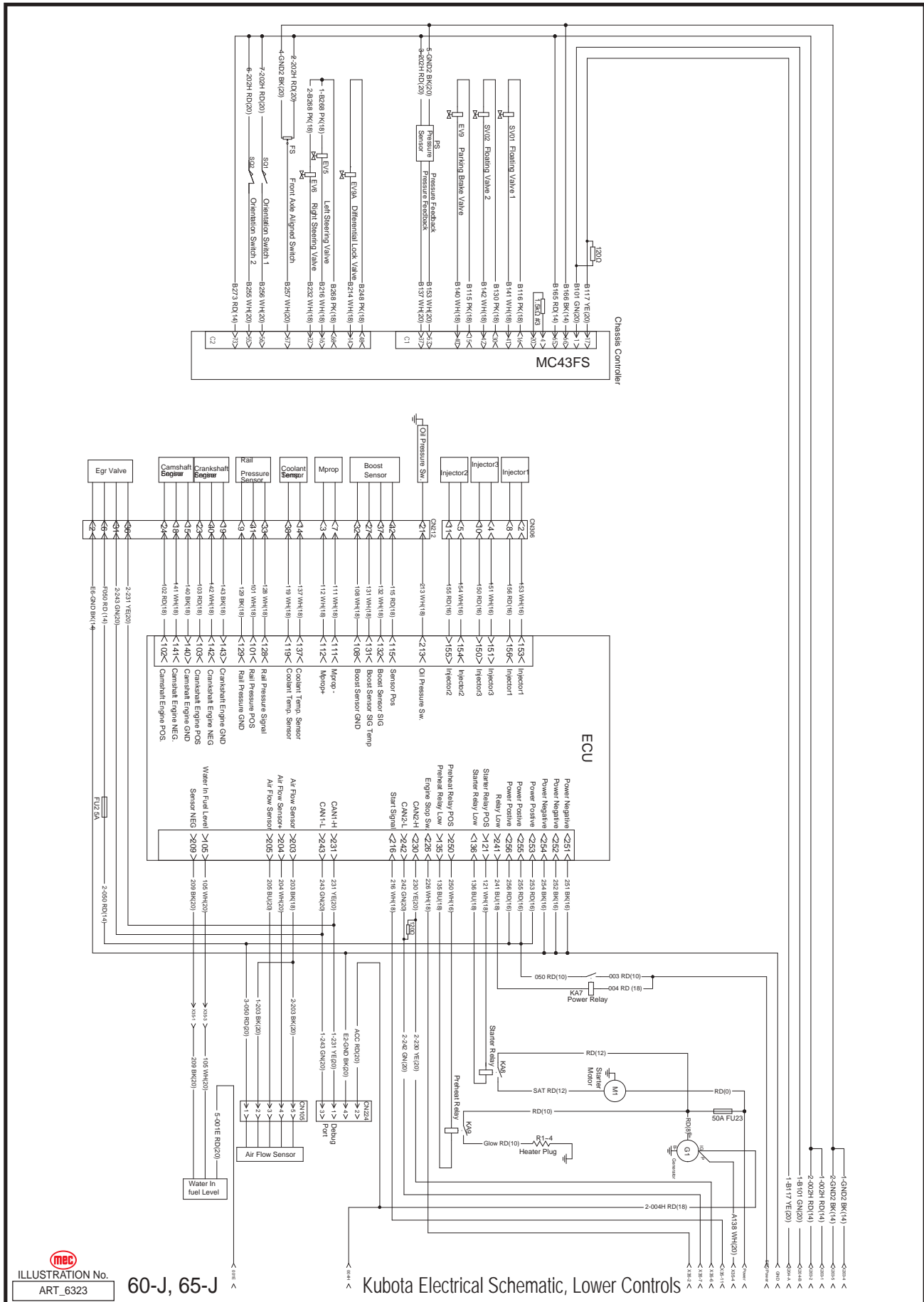

ILLUSTRATION No. ART_6323

60-J, 65-J

Kubota Electrical Schematic, Lower Controls



Electrical Schematic, Chassis, Kubota Engine

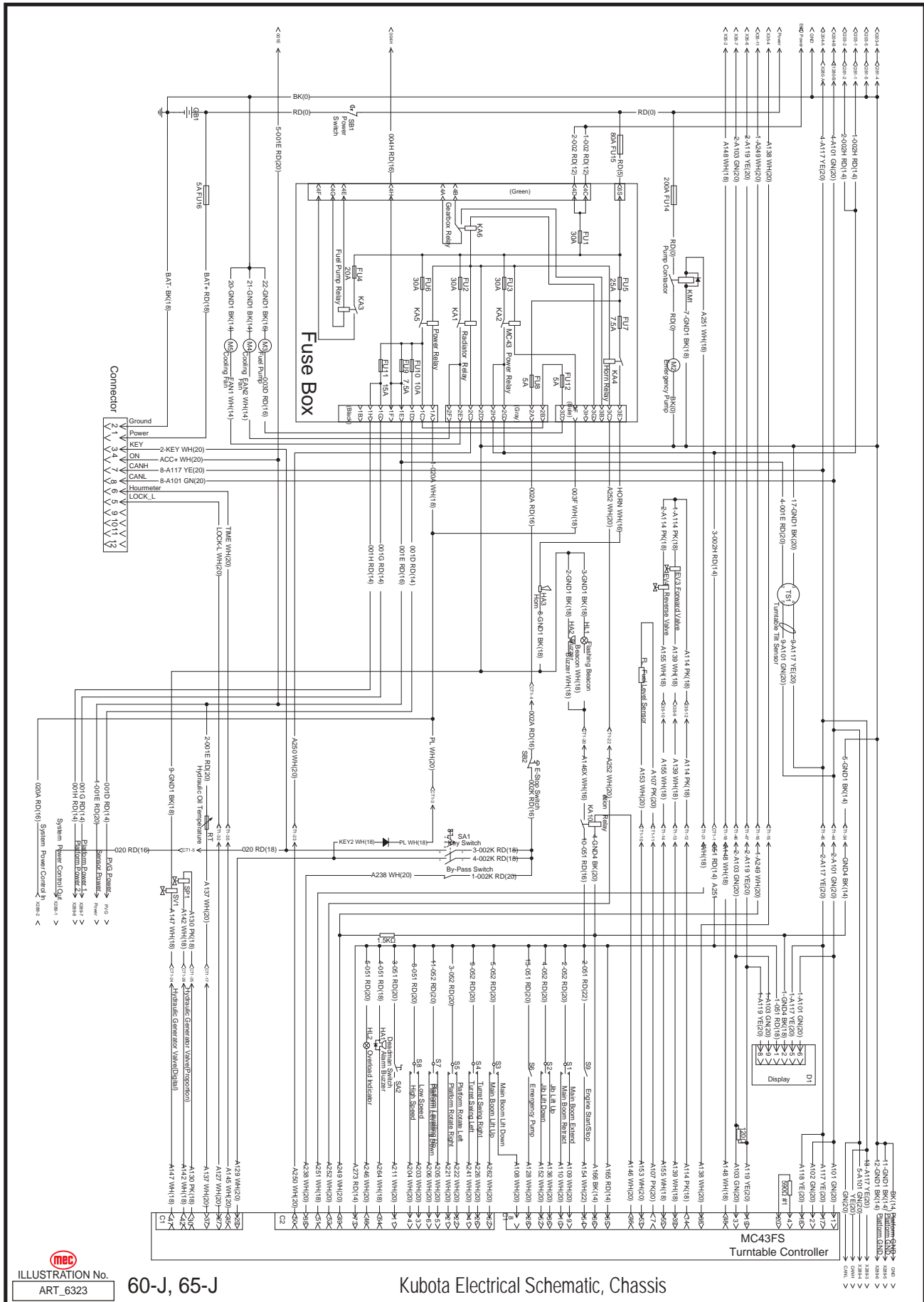

ILLUSTRATION No. ART_6323

60-J, 65-J

Kubota Electrical Schematic, Chassis



Electrical Schematic, Upper Controls, Kubota Engine

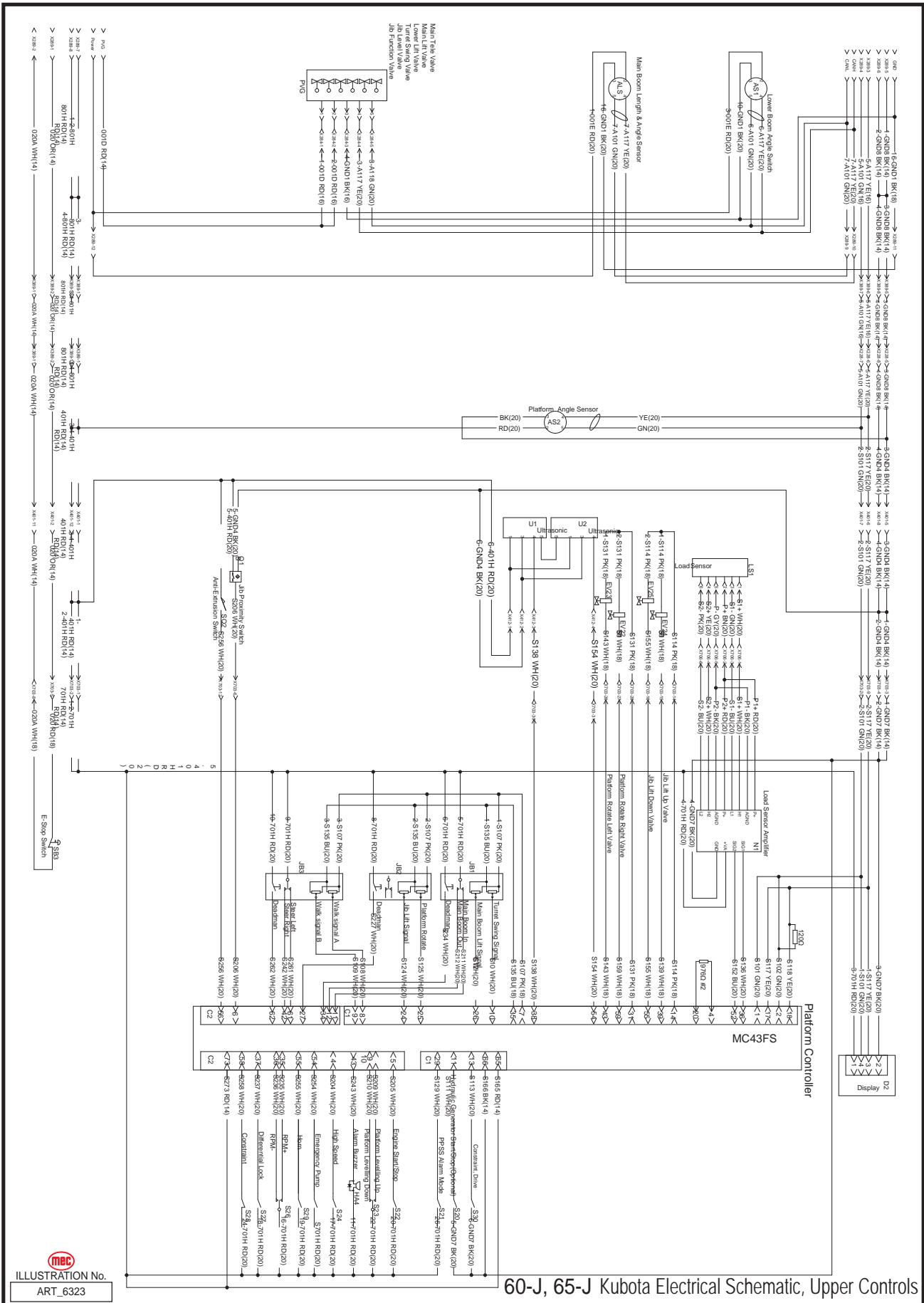

ILLUSTRATION No.
ART_6323

60-J, 65-J Kubota Electrical Schematic, Upper Controls



Hydraulic Schematic, Part 1

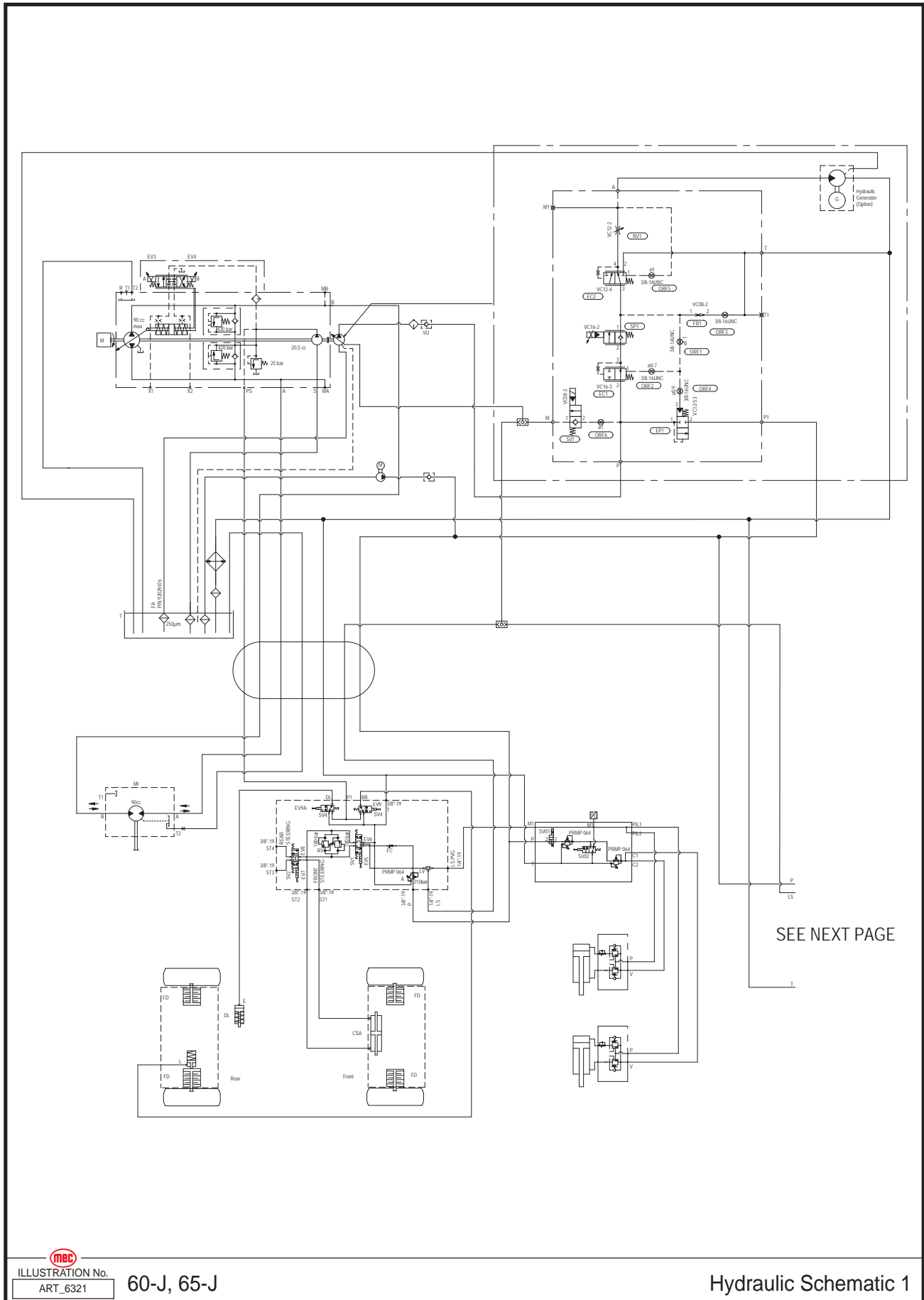
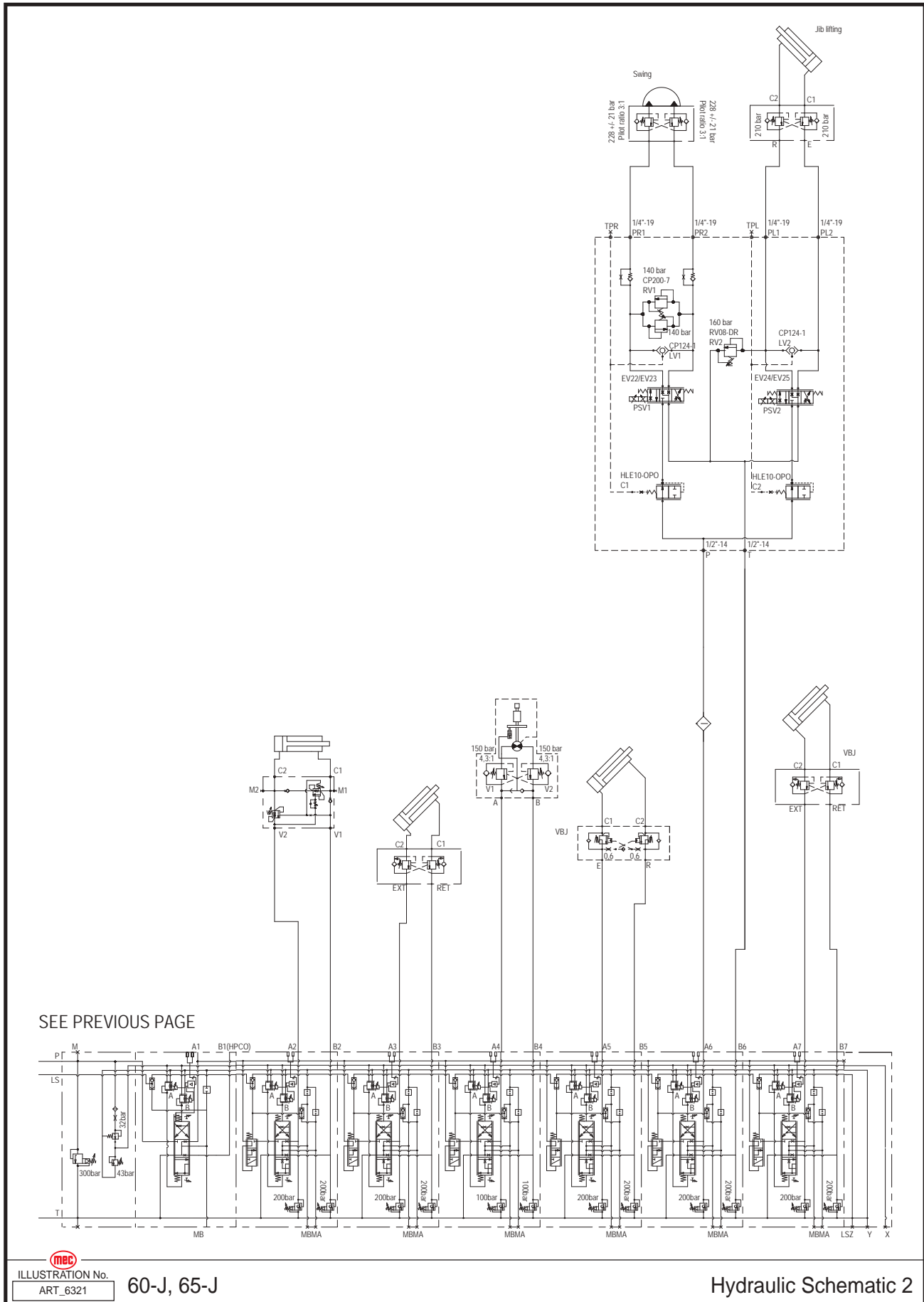

ILLUSTRATION No. **60-J, 65-J**
ART_6321

Hydraulic Schematic 1



Hydraulic Schematic, Part 2



SEE PREVIOUS PAGE

ILLUSTRATION No.
ART_6321

60-J, 65-J

Hydraulic Schematic 2