

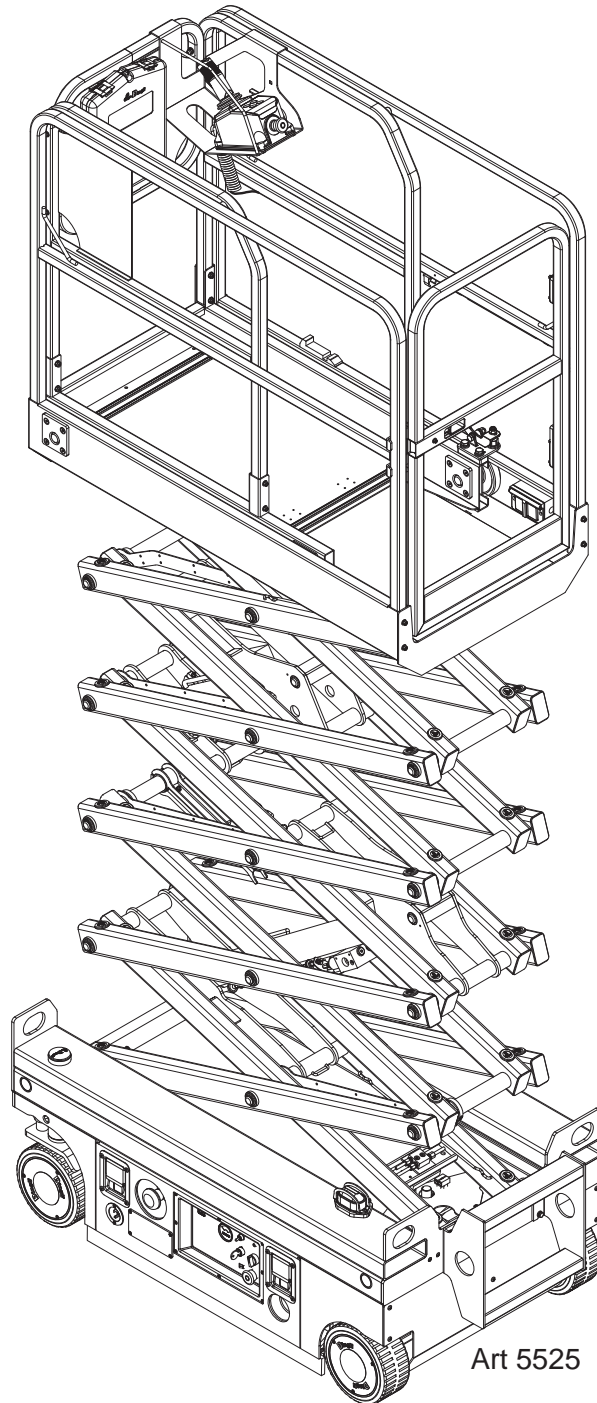

Operator's Manual

Micro19



Meets requirements of ANSI A92.20-2020 and CSA B354.6-2019.
Serial Number Range 16911000 - Up

Part # 95335
November 2025

Revision History

Date	Reason for Update
July 2021	New Release
April 2025	Updated Brake Release Instructions on page 37.



MEC Aerial Work Platforms

1401 S. Madera Avenue, Kerman, CA 93630 USA
Toll Free: 1-877-632-5438
Phone: 1-559-842-1500
Fax: 1-559-842-1520
info@MECawp.com
www.MECawp.com

Table of Contents

Section 1 - Introduction	1
<i>Introduction</i>	1
Section 2 - Safety	2
<i>Safety</i>	2
<i>Safety Alert Symbols & Fall Protection</i>	3
Section 3 - Specifications	4
<i>Specifications</i>	4
Section 4 - Hazards	5
<i>Electrocution Hazard</i>	5
<i>Tip-over Hazards</i>	8
<i>Fall & Collision Hazards</i>	10
<i>Additional Safety Hazards</i>	12
Section 5 - Components and Controls	13
<i>Component Locations</i>	13
<i>Platform Controls</i>	14
<i>Lower Controls</i>	15
Section 6 - Workplace Inspection	16
<i>Workplace Inspection</i>	16
Section 7 - Operating Instructions and Function Tests	17
<i>Functions Tests</i>	17
<i>Operating Instructions</i>	21
Section 8 - Battery Charging	26
<i>Battery Charging</i>	26
Section 9 - Maintenance.	27
<i>Maintenance</i>	27
<i>Lubrication</i>	29
<i>Pre-Start Inspection Checklist</i>	30
<i>Frequent Inspection Checklist</i>	31
<i>Maintenance Inspection Report</i>	32
Section 10 - Decals	33
<i>Decals</i>	33
<i>Serial Plate</i>	35
Section 11 - Troubleshooting	36
<i>Troubleshooting</i>	36
Section 12 - Transporting and Lifting Instruction	37
<i>Transport and Lifting Instructions</i>	37

Introduction

This Operator's Manual has been designed to provide you, the owner, user or operator, with the instructions and operating procedures essential to properly and safely operate your MEC Aerial Work Platform for positioning personnel, along with their necessary tools and materials, to overhead work locations.

This Operator's Manual and other manuals provided by MEC on the machine must be read and understood prior to operating your MEC Aerial Work Platform. The operator should not accept operating responsibility until he/she has read and understands the operator's manual as well as having operated the MEC Aerial Work Platform under supervision of an authorized, trained and qualified operator.



It is essential that the operator of the aerial work platform is not alone at the workplace during operation.

Modifications of this machine from the original design and specifications without written permission from MEC are strictly forbidden. A modification may compromise the safety of the machine, subjecting the platform occupants and personal around the machine to serious injury or death.

Your MEC Aerial Work Platform has been designed, built, and tested to provide safe, dependable service. Only authorized, trained and qualified personnel shall be allowed to operate or service the machine.

MEC, as manufacturer, has no direct control over machine application and operation. Proper safety practices are the responsibility of the owner, user and operator.

If there is a question on application and/or operation contact:



MEC Aerial Work Platforms

1401 S. Madera Avenue, Kerman, CA 93630 USA
Toll Free: 1-877-632-5438
Phone: 1-559-842-1500
Fax: 1-559-842-1520
info@MECawp.com
www.MECawp.com

Safety

DO NOT operate this machine until you have read and understood this manual, have performed the Workplace Inspection, Pre-Start Inspection and Routine Maintenance, and have completed all the test operations detailed in the Operating Instructions section.

Failure to read, understand and follow all safety rules, warnings, and instructions could result in serious injury or death. For your safety and the safety of those around you, you must operate your machine as instructed in this manual.

MEC designs aerial work platforms to safely and reliably position personnel, along with their necessary tools and materials, at overhead work locations. The owner/user/operator of the machine should not accept responsibility for the operation of the machine unless properly trained.

ANSI and other applicable standards identify requirements of all parties who may be involved with self-propelled elevating work platforms. The Manual of Responsibilities is considered a part of this machine and can be found in the manual compartment, located at the platform control station. To ensure safe use of machine, inspections and training specified in ANSI/SIA A92.22 & A92.24 must be performed at designated intervals as prescribed.



This product can expose you to chemicals known to the State of California to cause cancer and birth defects or other reproductive harm. For more information go to www.p65warnings.ca.gov.

Safety Alert Symbols & Fall Protection

MEC manuals and decals use symbols, colors and signal words to help you recognize important safety, operation and maintenance information.



RED and the word **DANGER** – Indicates an imminently hazardous situation which, if not avoided, will result in death or serious injury.



ORANGE and the word **WARNING** – Indicates a potentially hazardous situation which, if not avoided, could result in death or serious injury.



YELLOW with alert symbol and the word **CAUTION** – Indicates a potentially hazardous situation which, if not avoided, may result in minor or moderate injury.



YELLOW without alert symbol and the word **CAUTION** – Indicates a potentially hazardous situation which, if not avoided, may result in property damage.



GREEN and the word **NOTICE** – Indicates operation or maintenance information.

Fall Protection

Operators must comply with employer, job site and governmental rules regarding the use of personal protective equipment.

If required by your employer or job site, use personal fall protection equipment (PFPE) when operating this machine.

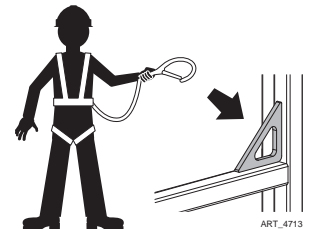

All personal fall protection equipment (PFPE) must comply with applicable governmental regulations, and must be inspected and used in accordance with the personal fall protection equipment (PFPE) manufacturer's instructions.

Fall restraint or fall arrest must be properly attached to a designated anchorage point when driving or operating the machine. Attach only one fall restraint or fall arrest to each anchorage point.

Specifications

Working Height*	Indoor	24ft 4in	7.6m
	Outdoor	21ft	6.4m
Platform Height	Indoor	18ft 4in	5.6m
	Outdoor	15ft	4.6m
Maximum Drive Height		18ft 4in	5.6m
Stowed Height	Top Guardrail	79in	2.0m
	Platform Floor	35in	0.9m
Platform Extension Length		23.6in	0.6m
Machine Weight** (Unloaded)		2,750lbs	1,247kg
Maximum Lift Capacity		500lbs	227kg
Deck Extension Capacity		250lbs (113kg)	
Maximum Occupants	Indoor	2 Person	
	Outdoor	1 Person	
Manual Force	Indoor	90lbs	400N
	Outdoor	45lbs	200N
Platform Length (Extended)		78in	2.0m
Platform Length (Retracted)		54in	1.4m
Width (Overall)		32in	0.81m
Platform Dimensions (Length x Width)		53.9x27.6in	1.37x0.7m
Wheel Base		44.5in	1.13m
Turning Radius - Inside		17.7in	0.45m
Ground Clearance - Stowed		2.4in	6cm
Ground Clearance - Elevated		0.6in	1.5cm
Drive Speed (Proportional)	Stowed	0-2.5mph	0-4km/h
	Raised/Extended	0-0.5mph	0-8km/h
Gradability		25% (14°)	
Maximum Side Slope - Stowed		5°	
Ground Pressure/Wheel	Min/Max	85/114psi	6.0/8.0kg/cm ²
Maximum Wheel Load		975lbs	442kg
Occupied Floor Pressure	Full Load Platform Retracted	244psf	1,191kg/m ²
	Platform Deck Extended	174psf	849kg/m ²
Maximum Operating Wind Speed		28mph	12.5m/sec (45km/h)
Tire Size		9x4in	230x100mm
Wheel Nut Torque		166.7ft-lb / 226Nm, Secured with cotter pin	
Hydraulic Pressure		2,320psi	160bar
Power System Voltage		24 Volt DC	
Battery Charger	Input	110-230 V AC, 50-60 Hz	
	Output	24 Volt DC	
Batteries		Two 12-Volt Deep Cycle 115Ah	
Chassis Inclination		1.5 Side, 3.0 Inline	
Meets requirements of ANSI A92.20-2020 and CSA B354.6-2019.			
*Working Height adds 6 feet (2 meters) to platform height.			
**Weight may increase with certain options.			

Electrocution Hazard

ELECTROCUTION HAZARD! THIS MACHINE IS NOT INSULATED!

DEATH OR SERIOUS INJURY will result from contact with or inadequate clearance from any electrically charged conductor.



You must maintain a **CLEARANCE OF AT LEAST 10 FEET (3.05 meters)** between any part of the machine, or its load, and any electrical line or apparatus carrying over 300 Volts up to 50,000 Volts. One foot (30.5 centimeters) additional clearance is required for every additional 30,000 Volts.

Observe Minimum Safe Approach Distance.

This machine is not electrically insulated and will not provide protection from contact with or proximity to electrical current.

Maintain safe distances from electrical power lines and apparatus in accordance with applicable government regulations and the following chart:

Voltage	Minimum Safe Approach Distance	
	Feet	Meters
Phase to Phase		
0 to 300 Volts	Avoid Contact	
Over 300V to 50kv	10ft	3.1m
Over 50KV to 200KV	15ft	4.6m
Over 200KV to 350KV	20ft	6.1m
Over 350KV to 500KV	25ft	7.6m
Over 500KV to 750KV	35ft	10.7m
Over 750KV to 1000KV	45ft	13.7m



Allow for platform movement, electrical line sway or sag and beware of strong or gusty winds.

Keep away from the machine if it contacts energized power lines. Personnel on the ground or in the platform must not touch or operate the machine until energized power lines are shut off.

Do not use the machine as a ground for welding.

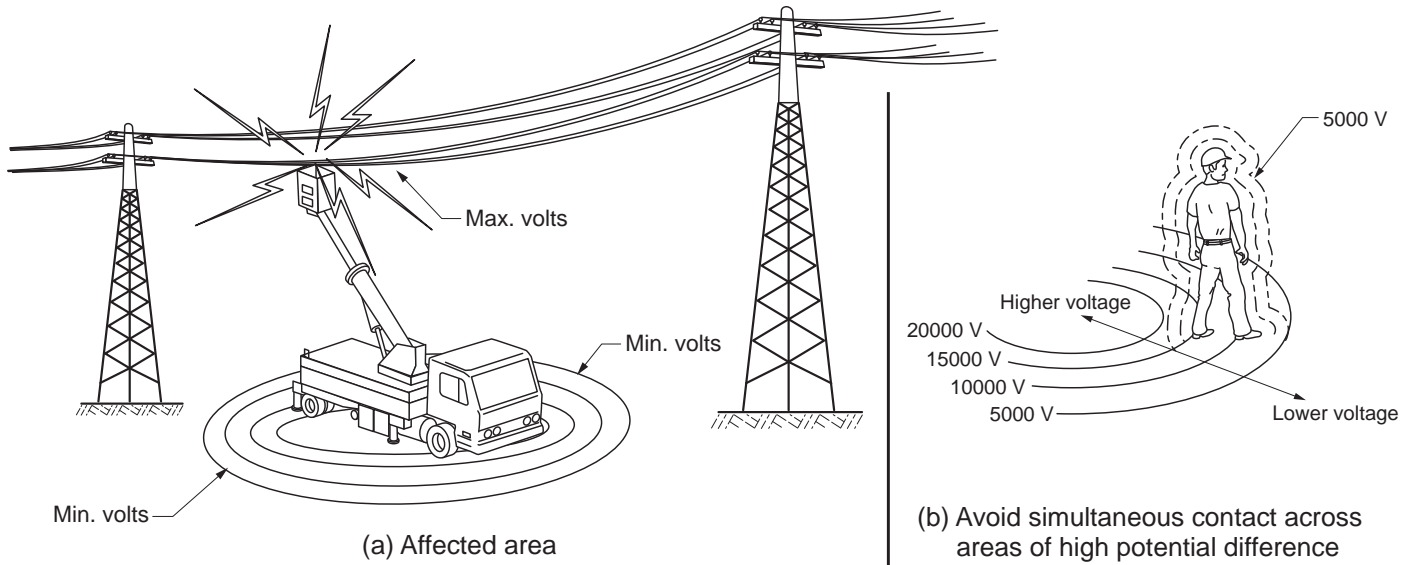

CLEARANCES FROM LIVE AERIAL CONDUCTORS

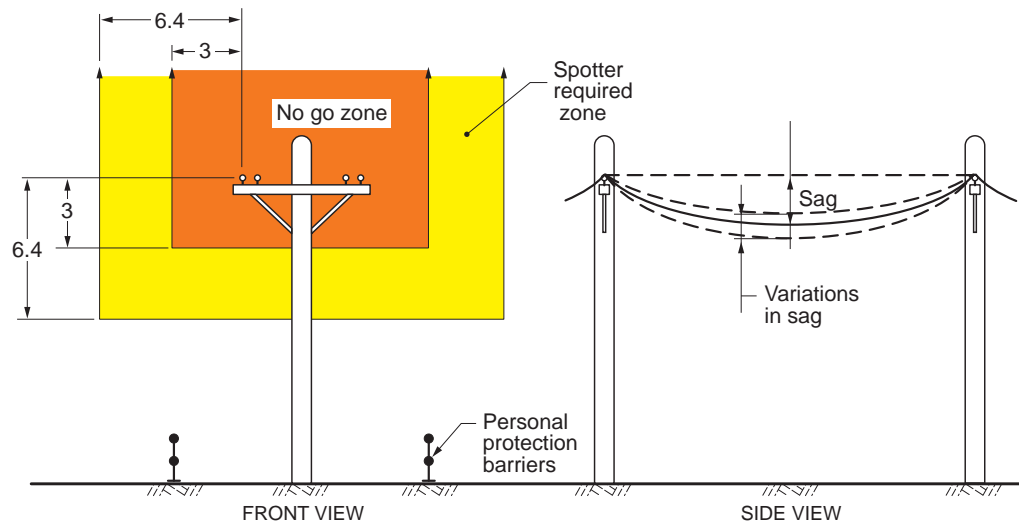

(a) Distribution lines up to and including 133 kV

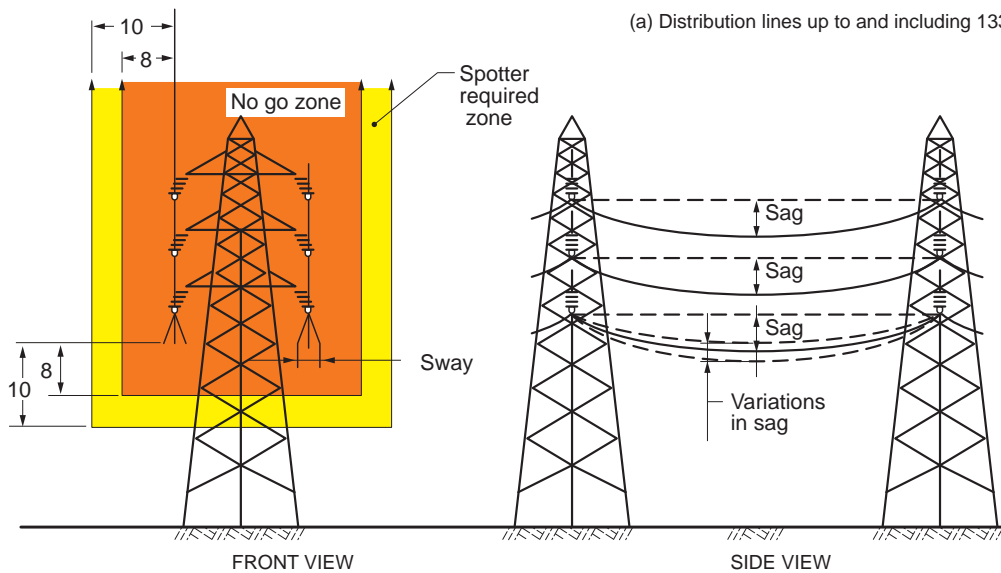

(b) Transmission lines greater than 133 kV

LEGEND

- = No shading, in the front views, indicates no proximity requirements
- = Light shading indicates spotter is required
- = Heavy shading indicates the NO GO ZONE

When working in the area of energized conductors the user shall direct and the operator shall comply with the requirements to:

- 1) Stay at least 10 feet (3.05 meters) away from power lines with any part of their body, conductive object or any part of the MEWP (Mobile Elevating Work Platform).
- 2) If work requires working nearer than 10 feet (3.05 meters), stop and consult a qualified person with respect to electrical transmission and distribution to have appropriate measures taken (such as de-energizing and grounding).
- 3) If there is a question that the power lines may carry more than 50kV, consult a qualified person with respect to electrical transmission and distribution before proceeding.
- 4) If working or approaching closer than explained above, it shall only be done by a qualified person with respect to electrical transmission and distribution. Only qualified persons may work on electric circuit parts or equipment that has not been de-energized. Such persons shall be capable of working safely on energized circuits and shall be familiar with the proper use of special precautionary techniques, personal protective equipment, insulating and shielding materials and insulated tools.

Tip-over Hazards

DO NOT exceed the maximum platform capacity. The weight of options and accessories will reduce the rated platform capacity and must be factored into the total platform load. Refer to the decals on the options.

DO NOT elevate the platform when the machine is on a surface that is soft and/or on a slope.

DO NOT elevate the platform unless the machine is on a firm, level surface.

DO NOT depend on the tilt alarm as a level indicator. STOP if the tilt alarm sounds and the red light illuminates when the platform is raised. Use extreme caution to lower the platform. Move the machine to a firm, level surface.

Driving: DO NOT drive the machine on a slope that exceeds the maximum uphill, downhill or side slope rating. Slope rating applies to machines in the stowed position.

Driving in stowed position: Use extreme care and reduce speed when driving across uneven terrain, debris, unstable or slippery surfaces, and near holes or drop-offs.

Driving with the platform elevated: DO NOT drive on or near uneven terrain, unstable surfaces, curbs, drop-offs or other hazardous conditions. DO NOT drive the machine faster than 0.7mph (1.1km/h) while elevated.

DO NOT push off or pull toward any object outside the platform. DO NOT push the machine or other objects with the platform. DO NOT contact adjacent structures with the platform.

DO NOT tie the platform to adjacent structures.

Maximum Allowable Side Force
45lbs (200N) per person

DO NOT use the platform controls to free a platform that is caught, snagged or otherwise prevented from normal motion by an adjacent structure.

DO NOT elevate the platform when wind speeds are in excess of 28mph (12.5m/s). If wind speeds exceed 28mph (12.5m/s) when the platform is elevated, carefully lower the platform and discontinue operation.

DO NOT increase the surface area of the platform (i.e. cover the rails with tarp or plywood). Increased surface area exposed to the wind will decrease machine stability.

DO NOT attach overhanging loads or use the machine as a crane. DO NOT place loads outside the platform perimeter.



Art_2828



Art_2834



Art_2833



Art_2831



Art_2832

NEVER transport tools and materials unless they are firmly secured. Secure all tools and loose materials.

NEVER alter or disable any machine components.

NEVER replace any part of the machine with items of different weight or specification.

NEVER modify or alter the work platform without written permission from MEC.

NEVER place ladders or scaffolds in the platform or against any part of the machine.

NEVER use the machine on a moving or mobile surface or vehicle.

Ensure that all tires are in good condition and lug nuts are properly torqued.

DO NOT operate the machine with the chassis trays open.

DO NOT alter or disable the limit switches or machine components that in any way affect safety and stability.

DO NOT replace items critical to machine stability with items of different weight or specification. DO NOT modify or alter this machine without prior written permission from the manufacturer.

DO NOT use batteries that weigh less than the original equipment. Each battery must weigh 72lbs (32.7kg). The batteries must weigh a minimum of 144lbs (65.4kg).

Fall & Collision Hazards

Fall Hazards

DO NOT sit, stand or climb on the platform guard rails. Maintain a firm footing on the platform floor at all times.

DO NOT exit the platform when elevated. DO NOT climb down from the platform when elevated.

Keep the platform floor clear of debris.

DO NOT fasten a fall restraint lanyard to an adjacent structure.

Ensure that the platform entry is properly closed and secured before operating the machine.

Ensure that the guard rails are properly installed and in good condition before operating the machine.

Operators must comply with employer and job site rules and governmental regulations regarding the use of personal protective equipment.



Collision Hazards

Check path before moving for equipment, materials or other obstructions.

Check path before moving for overhead obstructions.

Check path before moving for crushing hazards when holding the platform rail.

Be aware of limited sight distance and blind spots when driving or operating.

Be aware of extended platform position(s) when moving the machine.

Observe and use color-coded direction arrows on the platform controls and platform decal plate for drive and steer functions.

Reduce travel speed when moving the machine on slopes, when near personnel and obstacles, or when surface conditions are wet, slippery or otherwise limiting.

DO NOT operate in the path of any crane unless the controls of the crane have been locked out and/or precautions have been taken to prevent any possible collision.

Stunt driving and horseplay are PROHIBITED.

Watch for personnel and obstructions below the platform when lowering the platform.



Keep hands and limbs out of scissors.

Use common sense and planning when operating the machine with the controller from the ground. Maintain safe distances between the operator, the machine and fixed objects.

Additional Safety Hazards

Explosion and Fire Hazards

- DO NOT operate the machine in hazardous locations or locations where potentially flammable or explosive gases or particles may be present.

Damaged Machine Hazards

- Conduct a thorough pre-start inspection of the machine and test all functions before each work shift to check for damage, malfunction and unauthorized modification. Tag and remove a damaged, malfunctioning or modified machine from service. DO NOT use a damaged, malfunctioning or modified machine.
- Routine maintenance must be performed by the operator before each work shift. Scheduled maintenance must be performed by a qualified service technician at scheduled intervals. Tag and remove from service any machine that has not had scheduled preventative maintenance performed.
- Check that all safety and instructional decals are in place and undamaged.
- Check that the operator's, safety and responsibilities manuals are present in the storage container located in the platform. All manuals must be complete, undamaged and readable.

Bodily Injury Hazards

- DO NOT operate the machine when there is a hydraulic fluid or air leak. Hydraulic fluid or air under pressure can penetrate and/or burn skin.
- All compartments must remain closed and secure during machine operation. Improper contact with components under any cover will cause serious injury. Only trained maintenance personnel should access compartments. The operator should only access a compartment when performing pre-operation inspection.

Weld Line to Platform Safety (if equipped)

- Read, understand and follow all warnings and instructions provided with the welding power unit.
- Do not connect weld leads or cables unless the welding power unit is turned off at the platform controls.
- DO NOT operate unless the weld cables are properly connected.
- DO NOT connect the ground lead to the platform.

Battery Safety - Burn Hazards

- Batteries contain acid. Always wear protective clothing and eye wear when working with batteries.
- Avoid spilling or contacting battery acid. Neutralize battery acid spills with baking soda and water.

Battery Safety - Explosion Hazard

- Keep sparks, flame and lighted tobacco away from batteries. Batteries emit explosive gas. The battery tray should remain open during the entire charging cycle.

Battery Safety - Electrocutation Hazard

- Avoid contact with electrical terminals.

Component Locations

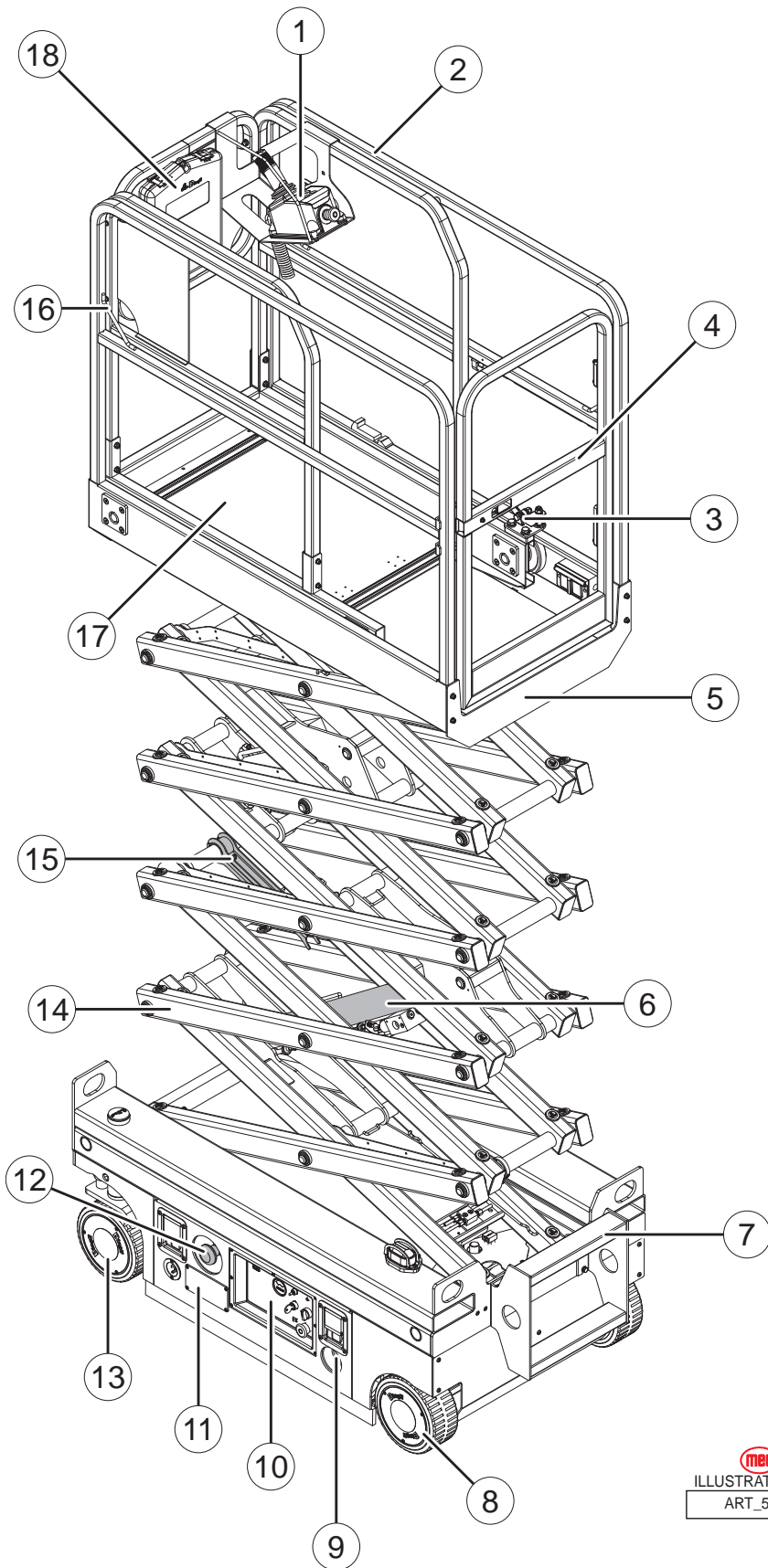

- 1) Platform Controller
- 2) Platform Guard Rails
- 3) Platform Extension Release Pedal
- 4) Platform Entry Gate
- 5) Main Platform
- 6) Lift Cylinder
- 7) Entry Ladder
- 8) Drive Wheels
- 9) Emergency Lowering Knob
- 10) Ground Control Panel
- 11) Batteries Charger
- 12) Main Power Switch
- 13) Steer Wheels
- 14) Scissor
- 15) Safety Arms
- 16) Lanyard Anchorage Point
- 17) Platform Extension
- 18) Manual Storage Container

 ILLUSTRATION No.
 ART_5545

Platform Controls

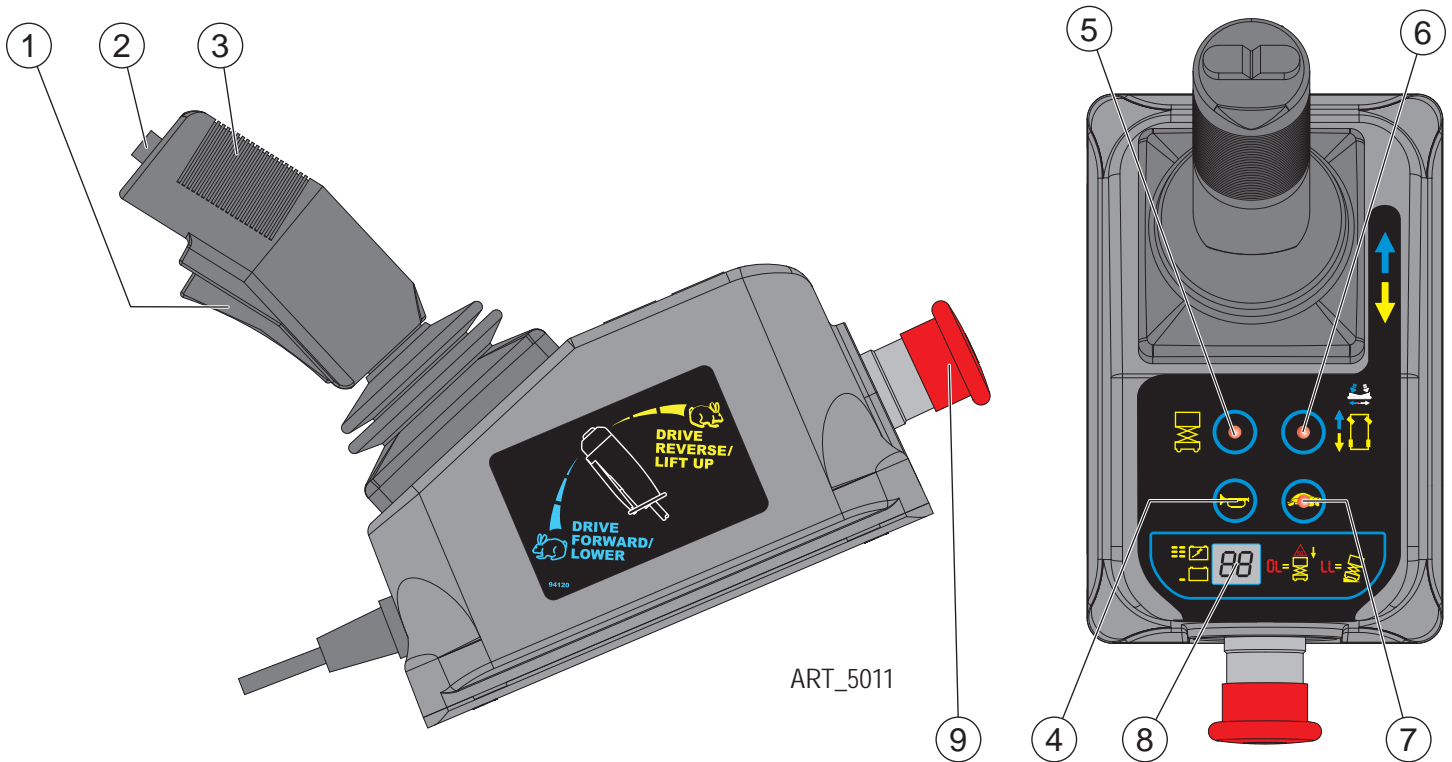

ART_5011



WARNING

ALWAYS be aware of the machine's position and of your surroundings before activating any control function.

Control		Description
1	Function Enable Switch	Squeeze the Function Enable Switch to enable Lift & Drive & Steer functions from Control Handle.
2	Steer Switch	Using your thumb press the thumb rocker switch in either direction to activate Steer Left or Right function.
3	Control Handle	Drive Proportionally controls Forward and Reverse travel.
		Lift Proportionally controls Lift and Lower functions.
4	Horn Button	Press to sound warning horn.
5	Lift Select	Press this button to select the Lift function.
6	Drive Select	Press this button to select the Drive function.
7	Drive Speed Select	Press this button to activate the slow or fast drive function. Light on indicates Low Speed Drive is selected. Light off indicates High Speed Drive is selected.
8	LED Display	Indicates the state of battery charge and displays diagnostic codes when necessary.
9	Emergency Stop Switch	Pull the button out to the On position (pulled out) to operate the machine. Push in the Emergency Stop switch at any time to stop all machine functions.

Lower Controls

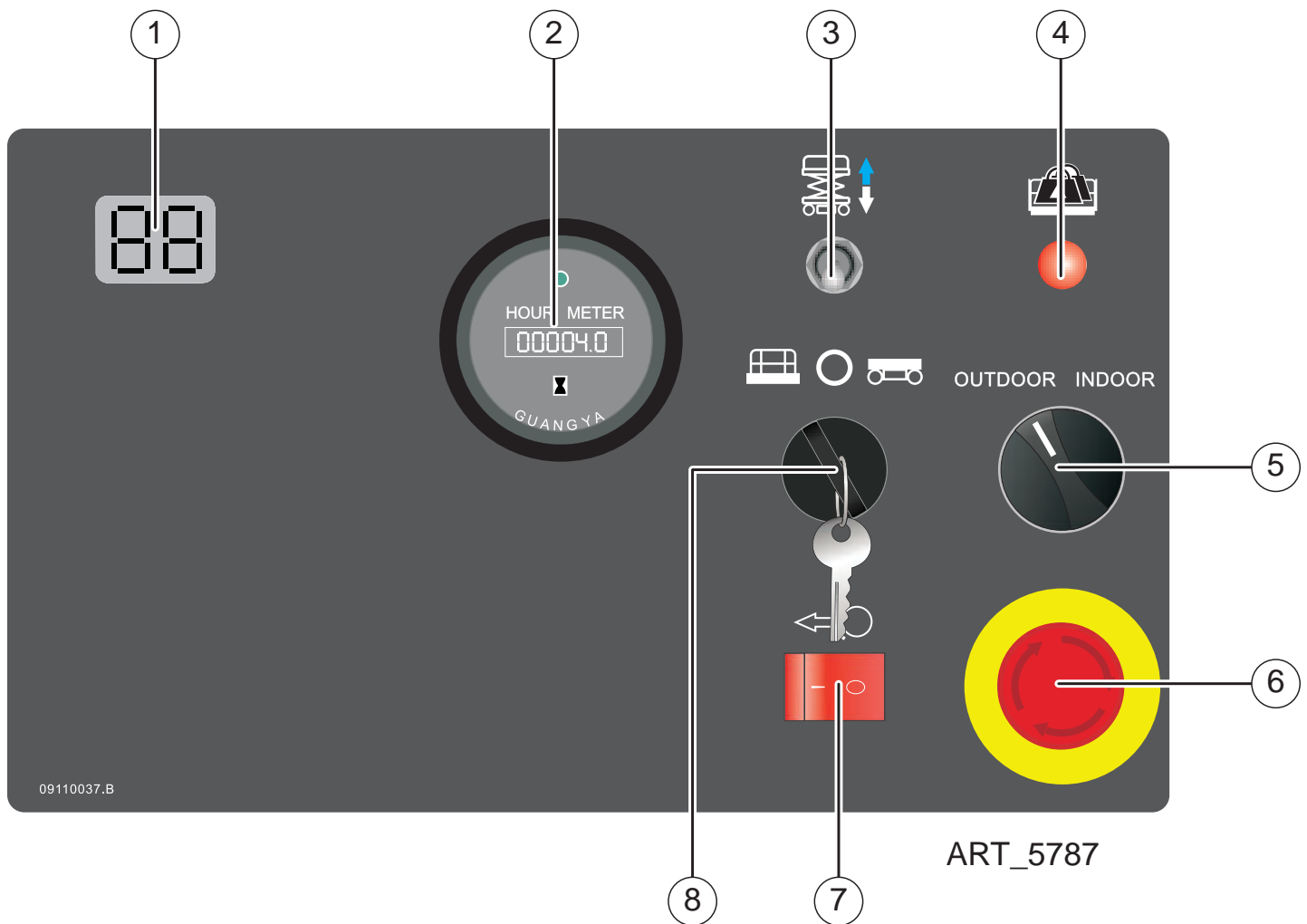

ART_5787



WARNING

ALWAYS be aware of the machine's position and of your surroundings before activating any control function.

Control		Description
1	LED Display	Indicates the state of battery charge and displays diagnostic codes when necessary.
2	Hour Meter	The hour meter displays the number of hours the machine has operated.
3	Platform Lift Switch	With the Key Switch in the Base position, move this switch up to lift the platform or down to lower the platform.
4	Platform Overload	Indicates too much weight on the platform. Remove weight from the platform to restore function and continue.
5	Outdoor/Indoor Switch	Outdoors Select to limit the maximum height when outdoors.
		Indoors Select to allow unrestricted height when indoors.
6	Emergency Stop Switch	Pull the button out to the On position (pulled out) to operate the machine. Push in the Emergency Stop switch at any time to stop all machine functions.
7	Brake Release Switch	See page 37 for instructions.
8	Key Switch	Platform Select to operate from the platform control panel.
		Off Select to stop operation from either control panel.
		Base Select to operate from the base control panel.

Workplace Inspection

DO NOT operate this machine until you have read and understood this manual, have performed the Workplace Inspection, Pre-Start Inspection and Routine Maintenance, and have completed all the test operations detailed in the Operating Instructions section.

Inspect the workplace and determine whether the workplace is suitable for safe machine operation. Do this before moving the machine to the workplace.

Be sure the lift is the correct machine for the job.

Be aware of workplace conditions, and continue to watch for hazards while operating the machine.

Workplace Inspection

Before operating the machine, check the workplace for all possible hazards, including but not limited to:

- Drop-offs or holes, including those concealed by water, ice, mud, etc.
- Sloped, unstable or slippery surfaces
- Bumps, surface obstructions and debris
- Overhead obstructions and electrical conductors
- Other objects or equipment
- Hazardous locations and atmospheres
- Inadequate surface and support to withstand all load forces imposed by the machine
- Wind and weather conditions
- The presence of unauthorized personnel
- Other possible unsafe conditions

Functions Tests

DO NOT operate this machine until you have read and understood this manual, have performed the Workplace Inspection, Pre-Start Inspection and Routine Maintenance, and have completed all the test operations detailed in the Operating Instructions section.

This section provides instructions and tests for each function of machine operation. Follow all safety rules and instructions. The operator must conduct inspections and a Functions Test of the machine before each work shift to check that all machine systems are working properly.

Test the machine on a firm level surface with no debris, drop-offs, potholes or overhead obstructions. Perform each step outlined in this section.

This machine shall only be operated by trained and authorized personnel. If multiple operators use this machine, all must be trained, qualified and authorized to use it. New operators must perform a Pre-Start Inspection and Functions Test prior to operating the machine.

Operators must comply with all employer and job site rules and governmental regulations regarding the use of personal protective equipment.

DO NOT use a machine that is malfunctioning. If any function does not perform as described, tag the machine and remove for repair by a qualified service technician. After repairs are completed, a Pre-Start Inspection and Functions Test must be performed before using the machine.



Check the area above and around the machine for obstructions and electrical power lines before operating the machine. The machine must have space to allow full elevation of platform.

Prestart

Perform a Pre-start Inspection (see page 30). Check the red Emergency Stop buttons at both the lower control and platform controls, pull them both out to reset.



ART_3353

Check the red Main Power/Lower Emergency Stop button. Must be in the On position (pulled out).

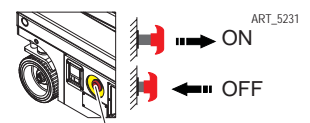

Main Power/ Lower Emergency Stop Switch

Functions Test

1. Select a test area that is firm, level and free of obstruction.
2. Be sure the battery pack is connected.
3. Pull the main power switch to the On position (pulled out).

At the Ground Controls

1. Pull the red Emergency Stop button out to the On position (pulled out) at both the ground and

platform controls.

2. Turn the Key Switch to the ground control.
3. Observe the diagnostic LED readout on the ECU window located at the Platform Controls.
 - **Result:** The LED should look similar to the picture right.

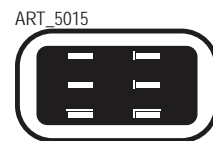

Test the Emergency Stop Function

1. Push in the ground red Emergency Stop button to the Off position (pushed in).
 - **Result:** No functions should operate.
2. Pull out the ground red Emergency Stop button to the On position (pulled out).

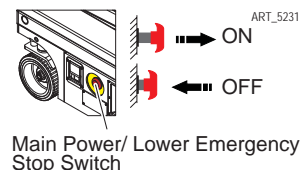

Test the Platform Lift/Lower Functions



Check the area above and around the machine for obstructions and electrical power lines before operating the machine.

A buzzer with different sound frequency is controlled by the central system. The descent alarm sounds at 60 beeps per minute. The alarm that goes off when the machine is not level or is the pothole guards have not deployed sounds at 150 beeps per minute.

1. At the lower controls, turn the Key Switch to the Off position or Platform position.
2. At the lower controls, move the Platform Lift Switch up or down.
 - **Result:** No function should operate.
3. Turn the Key Switch to the lower controls.
4. At the lower controls, move the Platform Lift Switch up.
 - **Result:** The platform should raise.
5. At the lower controls, move the Platform Lift Switch down.
 - **Result:** The platform should lower to end. The descent alarm should sound while the platform is lowering.

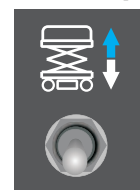

Test the Emergency Lowering Function

1. Activate the up function and raise the platform approximately 2 feet (60 centimeters).
2. Pull the Emergency Lowering Handle.
 - **Result:** The platform should lower. The descent alarm will not sound.

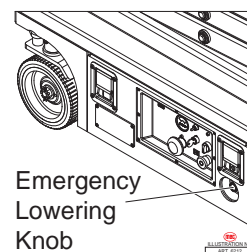

At the Platform Controls

1. Turn the Key Switch to platform control.

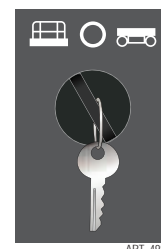

Test the Emergency Stop Function

1. Push in the ground red Emergency Stop switch to the Off position (pushed in).
 - **Result:** No functions should operate.
2. Pull out the ground red Emergency Stop switch to the On position (pulled out).

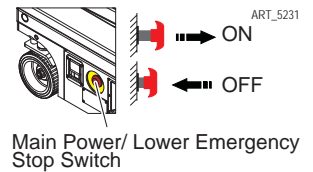

Test the Horn

1. Push the horn button.
 - **Result:** The horn should sound.



Test the Function Enable Switch and Platform Lift/Lower Functions



Check the area above and around the machine for obstructions and electrical power lines before operating the machine.

1. Press the lift function select button.
2. Do not hold the Function Enable Switch on the control handle.
3. Slowly move the control handle forward/downward, then rearward/upward.
 - **Result:** No functions should operate.
4. Press and hold the Function Enable Switch on the control handle.
5. Slowly pull the control handle rearward/upward.
 - **Result:** The platform should raise. The pothole guards should deploy.
6. Release the control handle.
 - **Result:** The platform should stop raising.
7. Press and hold the Function Enable Switch. Slowly push the control handle forward/downward.
 - **Result:** The platform should lower. The descent alarm should sound while the platform is lowering.



Test the Steering Functions

Note: When performing the steer and drive function tests, stand in the platform facing the steer end of the machine.

1. Press the drive function select button.
2. Press and hold the Function Enable Switch on the control handle.
3. Depress the thumb rocker switch on top of the control handle in the direction identified by the blue left arrow on the control panel.
 - **Result:** The steer wheels should turn in the direction that the blue left arrow points on the control panel.
4. Depress the thumb rocker switch in the direction identified by the white right arrow on the control panel.
 - **Result:** The steer wheels should turn in the direction that the white right arrow points on the control panel.

Test Drive and Braking

1. Press the drive function select button. The indicator light should turn on.
2. Press and hold the Function Enable Switch on the control handle.
3. Slowly move the control handle forward/downward until the machine begins to move, then return the handle to the center position.
 - **Result:** The machine should move forward, in the direction of the steering wheels, then come to an abrupt stop.
4. Press and hold the Function Enable Switch on the control handle.
5. Slowly move the control handle rearward/upward until the machine begins to move, then return the handle to the center position.
 - **Result:** The machine should move rearward, in the direction of the platform entry, then come to an abrupt stop.

Note: The brakes must be able to hold the machine on any slope it is able to climb.

Test Elevated Platform Drive Speed

1. Press the lift function select button.
2. Press the Function Enable Switch. Raise the platform approximately 5 feet (1.5 meters) from the ground.
 - **Result:** The pothole guards should deploy.
3. Press the drive function select switch.
4. Press and hold the Function Enable Switch on the control handle.
5. Slowly move the control handle to the full drive position.
 - **Result:** The maximum achievable drive speed with the platform raised should not exceed 0.55 feet per second (16.7 centimeters per second).
 - If the drive speed with the platform raised exceeds 0.55 feet per second (16.7 centimeters per second), immediately tag and remove the machine from service.



Platform Overload Test Procedure

1. Park the machine on firm, level surface and remove all contents from platform.
2. Consult the Platform Capacity data plate for the Maximum Platform Weight Capacity information.
3. Load (approximately) 90% of that weight in the platform.
4. Lift the platform using the lower control lift switch.
 - The platform should raise and the display should read “90” indicating 90% load.
5. Add 50lbs (22.7kg) to the platform in addition to the weight added in step 3 then lift the platform.
 - The platform should lift 5-7 feet (1.5-2.1 meters) then stop lifting automatically. The alarms should sound and the display should read “OL”. Use Emergency Lowering cable to lower the platform.
6. **Results:**
 - The platform stops lifting with less than the maximum rated platform capacity in the platform
 - OR**
 - The platform continues to lift with excessive weight in the platform.
 - Test Failed – recalibrate the overload system (refer to Overload Calibration in this section).
 - The Platform Overload Sensing System operates as described – Passed Test - Complete.

Operating Instructions



Check the area above and around the machine for obstructions and electrical power lines before operating the machine.

Emergency Stop

Push in the red Emergency Stop button to the Off position (pushed in) at the ground controls or the platform controls to stop all machine functions.

If any function operates when either red Emergency Stop button is pushed in, repair the Emergency Stop function before using the machine.

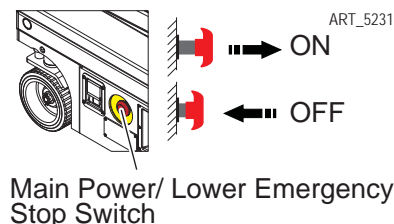

Emergency Lowering



If the control system fails while the platform is elevated, use the emergency lowering procedure to safely lower the platform.

Do not climb down the scissor assembly or exit the platform.

The Emergency Lowering System is used to lower the platform in case of power failure.

Pull the Emergency Lowering Handle to lower the platform.

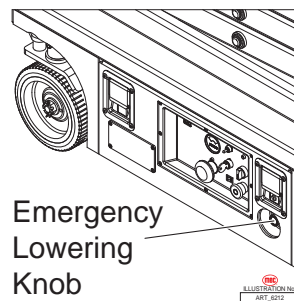

Indoor/Outdoor Switch

Select the working environment before using machine.

- Turn the switch to Outdoor to restrict platform height when working outdoors.
- Turn the switch to Indoor to allow unrestricted platform height when working indoors.



Platform Overload

Indicates too much weight on the platform.

Remove weight from the platform to restore function and continue.

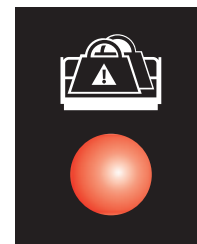

ART_5662

Operation from Ground

Drive and steer functions are not available from the ground controls.

1. Turn the Key Switch to ground control.
2. Pull the red Emergency Stop button out to the On position (pulled out) at both the ground and platform controls.
3. Be sure the battery pack is connected before operating the machine.



ART_4989



Check the area above and around the machine for obstructions and electrical power lines before operating the machine.

To Position Platform

Move the up/down toggle switch according to the markings on the control panel.

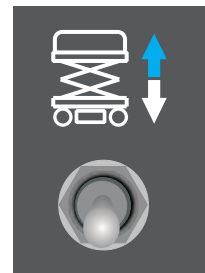

ART_4988

Operation from Platform

1. Turn the Key Switch to platform control.
2. Pull the red Emergency Stop button out to the On position (pulled out) at both the ground and platform controls.
3. Be sure the battery pack is connected before operating the machine.

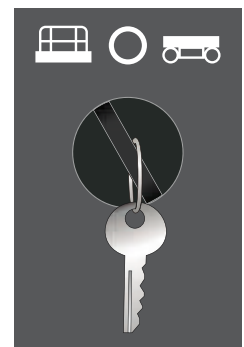

ART_4987



Check the area above and around the machine for obstructions and electrical power lines before operating the machine.

To Position Platform

1. Press the lift function select button.
2. Press and hold the Function Enable Switch on the control handle.
3. Pull the control handle upward to raise the platform.
4. Push the control handle downward to lower the platform.

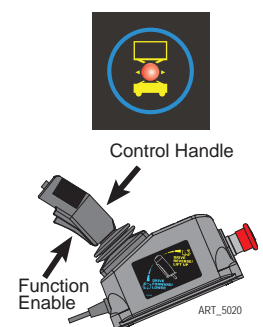

ART_5020

To Steer

1. Press the drive function select button.
2. Press and hold the Function Enable Switch on the control handle.
3. Turn the steer wheels with the thumb rocker switch located on the top of the control handle.

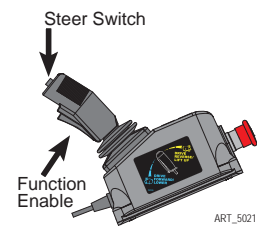

To Drive

1. Press the drive function select button.
2. Press and hold the Function Enable Switch on the control handle.
 - **Increase speed:** Slowly move the control handle off center.
 - Push the control handle forward to move forward. Pull the control handle rearward to move rearward.
 - **Decrease speed:** Slowly move the control handle toward center.
 - **Stop:** Return the control handle to center or release the Function Enable Switch.

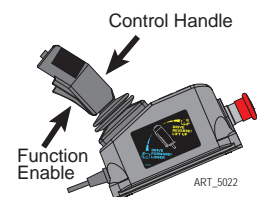

Use the color-coded direction arrows on the platform controls to identify the direction the machine will travel. Machine travel speed is restricted when the platform is raised.

Battery condition will affect machine performance. Machine drive speed and function speed will drop when the battery level indicator is flashing.

To Reduce Drive Speed

The drive controls can operate in two different drive speed modes.

- When the drive speed button light is on, slow drive speed mode is active.
- When the button light is off, fast drive speed mode is active.

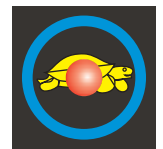

ART_5023

Press the drive speed button to select the desired drive speed.

Driving on a Slope

Determine the slope and side slope ratings for the machine and determine the slope grade.

- Maximum forward/rearward slope rating, stowed position 25%.
- Maximum side slope rating, stowed position 5°.

Note: Slope rating is subject to ground conditions and adequate traction.

To determine the slope grade

Measure the slope with a digital inclinometer OR use the following procedure. You will need:

- Carpenter's level
- Straight piece of wood, at least 3.3 feet (1 meter) long
- Tape measure

Lay the piece of wood on the slope.

At the downhill end, lay the level on the top edge of the piece of wood and lift the end until the piece of wood is level.

While holding the piece of wood level, measure the distance from the bottom of the piece of wood to the ground.

Divide the tape measure distance (rise) by the length of the piece of wood (run) and multiply by 100.

Example:

- Run = 12 feet / 3.6 meters
- Rise = 12 inches / 0.3 meters
- $12 \text{ inches} \div 12 \text{ feet} = 0.083 \times 100 = 8.3\%$
- $0.3 \text{ meters} \div 3.6 \text{ meters} = 0.083 \times 100 = 8.3\%$

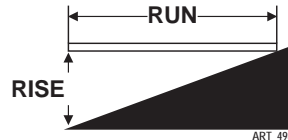

If the slope exceeds the maximum slope or side slope rating, the machine must be winched or transported up or down the slope. See Transport and Lifting section.

Operation from Ground with Controller



Use extreme caution when operating the machine with the controller from the ground.

Maintain safe distances between operator, machine and fixed objects.

Be aware of the direction the machine will travel when using the controller.

Battery Level Indicator

Use the LED diagnostic readout to determine the battery level.

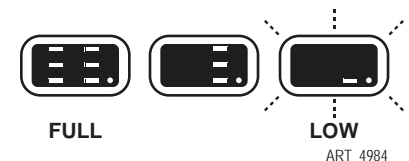

Maintenance Lock

1. Raise the platform approximately 7.2 feet (2.2 meters) from the ground.
2. Rotate the Maintenance Lock away from the machine and let it hang down.
3. Lower the platform until the Maintenance Lock rests securely on the link. Keep clear of the Maintenance Lock when lowering the platform.

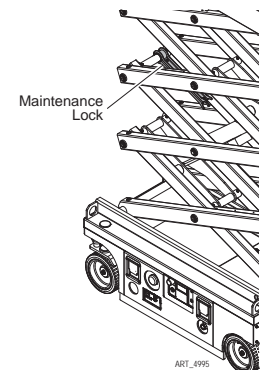

Don't engage the Maintenance Lock unless the platform is empty of tools and material.

To Extend and Retract the Deck Extension

1. Press the platform lock pin foot pedal on the extension deck.
2. Push the platform extension guardrail to extend the platform to the desired position.

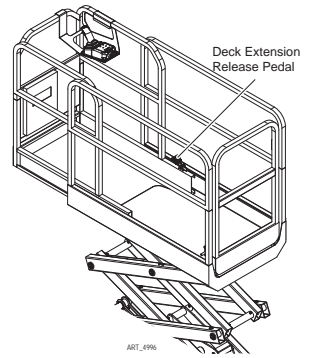

IF THE ROLL-OUT DECK IS EXTENDED CHECK FOR CLEARANCE UNDER DECK AREA BEFORE LOWERING PLATFORM.

Error Indicator Readout

The Error Indicator Readout is located at the Upper Controls station. Consult the Service & Parts Manual for Alarm Code descriptions. Manuals are available free online at www.MECawp.com.

If a load in excess of the rated load is detected the lift or lower will be restricted. The load must be removed before movement can occur.

The platform overload is measured when the machine is stationary and not in motion.

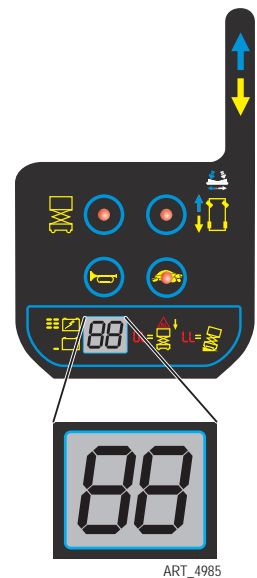

Shutdown Procedure

When finished with the machine, place the platform in the stowed position.

Park the machine on a level surface.

Turn the Key Switch to the Off position (pushed in) and remove the key to prevent unauthorized use. Carefully exit the platform using a constant three (3) point dismount/grip.

Always put the main power switch in Off position (pushed in) when leaving the machine at the end of the work day.

Charge the batteries.

Battery Charging

The charger surface can get hot while operating. Contact with the skin or surrounding materials should be avoided.



WARNING

To reduce the risk of an electric shock, connect only to a properly grounded single-phase (3 wire) outlet.

Do not use an external charger or booster battery.

Charge the battery in a well-ventilated area.



CAUTION

Use proper AC input voltage for charging as indicated on the machine.

Use only MEC authorized batteries and chargers.

The charger will indicate the status of the charge cycle.

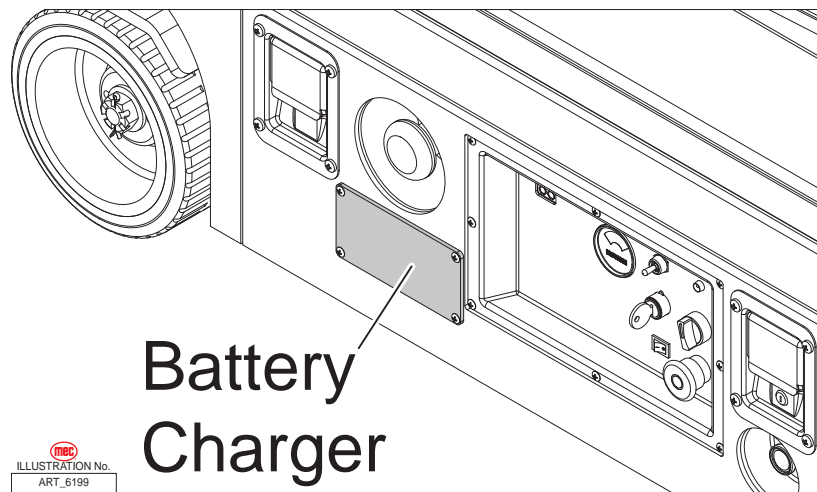



ILLUSTRATION No.
ART_6199

Maintenance

DO NOT operate this machine until you have read and understood this manual, have performed the **Workplace Inspection, Pre-Start Inspection and Routine Maintenance**, and have completed all the test operations detailed in the **Operating Instructions** section.

The operator must conduct a Pre-Start Inspection of the machine and test all functions before each work shift to check for damage, malfunction and unauthorized modification. The inspection is designed to discover if anything is apparently wrong with a machine before the operator performs the function tests.

Tag and remove a damaged, malfunctioning or modified machine from service. **DO NOT** use a damaged, malfunctioning or modified machine.

Use the Pre-Start Inspection to determine what Routine Maintenance is required. The operator may perform only the routine maintenance items specified in this manual.

IMPORTANT: Scheduled maintenance inspection checklists are included in this manual for use only by qualified service technicians. Only qualified service technicians may perform repairs to the machine. After repairs are completed, the operator must perform a Pre-Start Inspection before proceeding to the Functions Test.



Hydraulic fluid under pressure can penetrate and burn skin, damage eyes, and may cause serious injury, blindness, and death. Repair leaks immediately. Fluid leaks under pressure may not always be visible. Check for pin hole leaks with a piece of cardboard, not your hand.



NEVER perform work or inspection on the machine with the platform elevated without first blocking the scissor assembly with the Maintenance Lock (see page 24).

Perform scheduled maintenance at recommended intervals. Failure to perform scheduled maintenance at recommended intervals may result in a defective or malfunctioning machine and may result in injury or death of the operator. Keep maintenance records current and accurate.

Immediately report any damage, defect, unauthorized modification or malfunction to your supervisor. Any defect must be repaired prior to continued use. DO NOT use a damaged, modified or malfunctioning machine.



Never leave hydraulic components or hoses open. Plug all hoses and fitting immediately after disassembly to protect the system from outside contamination (including rain).

Never open a hydraulic system when there are contaminants in the air.

Always clean the surrounding area before opening hydraulic systems.

Use only recommended lubricants. Improper lubricants or incompatible lubricants may cause as much damage as no lubrication.



Watch for makeshift “fixes” which can jeopardize safety as well as lead to more costly repair.

Inspection and maintenance should be performed by qualified personnel familiar with the equipment.

Routine Maintenance



NEVER perform work or inspection on the machine with the platform elevated without first blocking the scissor assembly with the Maintenance Lock.

See page 24 for instructions.

IMPORTANT: The operator may perform only maintenance items on the Pre-Start Inspection Checklist. Frequent and Annual maintenance must be performed by qualified service technicians.

Pre-Start Inspection

Perform routine maintenance as identified in the Pre-Start Inspection Checklist on page 30.

Frequent and Annual Maintenance

Frequent Inspection Checklists and Annual Inspection Reports must be completed by qualified service technicians trained and authorized to perform maintenance on this machine, and must be done in accordance with the procedures outlined in the service manual. Scheduled maintenance inspection checklists are included in this manual for use by qualified service technicians.

Machines that have been out of service for more than three months must have the Frequent Inspection Checklists completed before returning to service.

Lubrication

Operator may perform routine maintenance only. Lubrication listed as Scheduled Maintenance must be performed by a qualified service technician.

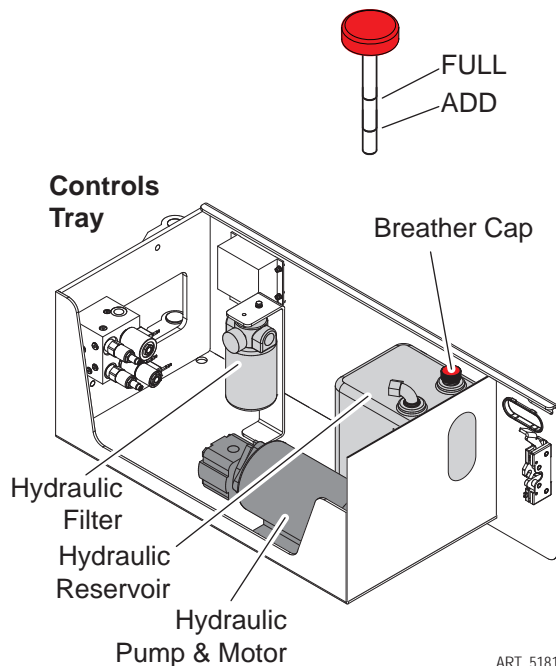

No.	Item	Specification	Frequency
1	Hydraulic Reservoir	<p>Mobile Fluid DTE 10, DTE 13 M, or AW32</p> <p>Do not substitute other fluids as pump damage may result.</p> <p>Check as shown above with platform in the stowed position. Fill as needed.</p>	<p>Routine Maintenance</p> <ul style="list-style-type: none"> Check hydraulic oil level every week <p>Scheduled Maintenance</p> <ul style="list-style-type: none"> Change yearly or every 600 hours, whichever occurs first
2	Hydraulic Cap Breather Filter and Hydraulic Filter	<p>Breather Filter (Located inside Filler Cap)</p> <p>Hydraulic Filter Canister</p>	<p>Scheduled Maintenance</p> <p>Normal Conditions</p> <ul style="list-style-type: none"> Change every six months or 300 hours, whichever occurs first <p>Severe Conditions--very dusty, exceptionally hot or exceptionally cold conditions</p> <ul style="list-style-type: none"> Change every three months or 150 hours, whichever occurs first

Pre-Start Inspection Checklist

The operator must conduct a Pre-Start Inspection of the machine before each work shift.

DO NOT use a damaged or malfunctioning machine.

	Be sure that the operator's manual are complete, legible and in the storage container located in the platform.
	Be sure that all decals are legible and in place. See Decals section.
	Check for hydraulic oil leaks.
	Check for battery fluid leaks.

Check the following components or areas for damage, improperly installed or missing parts and unauthorized modifications:

	Electrical components, wiring and electrical cables
	Battery connections
	Hydraulic hoses, fittings, cylinders and manifolds
	Battery pack and connections
	Drive motors
	Slide blocks/wear pads
	Tires and wheels
	Ground strap
	Limit switches, alarm and beacon
	Nuts, bolts and other fasteners
	Platform entry gate
	Beacons and alarms
	Maintenance Lock
	Platform extension
	Scissor pins and retaining fasteners
	Platform control handle
	Brake release components
	Pothole guards

Check entire machine for:

	Cracks in welds or structural components
	Dents or damage to machine
	Be sure that all structural and other critical components are present and all associated fasteners and pins are in place and properly tightened
	Be sure that guard rails are properly installed and secured, and that all pins and bolts are properly fastened.
	Be sure that the chassis trays are closed and latched and the batteries are properly connected.



NEVER perform work or inspection on the machine with the platform elevated without first blocking the scissor assembly with the Maintenance Lock. See page 24 for instructions.

Frequent Inspection Checklist



This checklist must be used at 3-month intervals or every 150 hours of machine use, whichever occurs first. Failure to do so could result in death or serious injury.

Frequent Maintenance Inspections should be conducted by qualified service technicians only. Photocopy this page for reuse. Keep inspections records up to date. Record and report all discrepancies to your supervisor. See the Service & Parts Manual for specific instructions.

Model Number _____ Serial Number _____ Hour Meter Reading _____

	Perform all checks listed on Pre-Start Inspection.
	Grease the Steering Yokes
	Inspect the condition of hydraulic fluid in the reservoir. Oil should be a clear and amber in color.
	Batteries
	Electrical Wiring
	Tires and Wheels
	Emergency Stop
	Key Switch
	Horn
	Drive Brakes
	Drive Speed, Stowed Platform
	Drive Speed, Raised Platform
	Drive Speed, Slow
	Tank Venting System
	Latch Components
	Test Down & Pothole Limit Switches
	Test Up Limit Switches

Additional maintenance requirements for severe conditions

If the machine is used in very dusty, exceptionally hot or exceptionally cold conditions, replace the Hydraulic Cap Breather Filter and Hydraulic Filter (under normal conditions replace every 6 months or 300 hours, whichever comes first).

Date _____ Inspected By _____

Maintenance Inspection Report

SE & MICRO Series Scissors

Fleet Equipment Number _____ Date _____
 Inspector Name _____ Inspector Co. _____
 Model Number _____ Address _____
 Serial Number _____
 Hour Meter _____ Signature _____
 Machine Owner & address _____

Maintain all service records in accordance with ANSI A92.24-2019

* If an inspection receives an "N", remove from service. Once repaired, place an "R" in the box.
 * Refer to the proper service manual for specific information, settings and torque specifications.

Key Y = Yes, Acceptable N = No, Remove from Service R = Repaired 0 = Not Applicable

QUARTERLY - Inspect only those marked "Q" **ANNUAL** - Inspect all items

	Q/A	Y/N/O	R
DECALS:			
Legible - undamaged/readable	Q		
Capacity decal correct for model	Q		
RAILS:			
Not damaged, all in place	Q		
All rail fasteners secure	Q		
Entry gate secure, closes properly	Q		
Manual box in good condition	Q		
Operators Manual in manual box	Q		
PLATFORM EXTENSION:			
Rolls in and out freely	Q		
Lock holds deck in place	Q		
Release pedal moves freely (lube)	Q		
ELEVATING ASSEMBLY:			
Scissor Slide Blocks, lubed	Q		
Maintenance Stand, good Cond	Q		
Beam structures: Straight, no cracks	A		
Welds: secure, no cracks	A		
Retaining Rings	A		
Cylinder Pins, secure	A		
ELECTRICAL:			
GFCI operates correctly	Q		
Wire harnesses good cond, secure	A		
Comm cable no damage, secure	A		
BASE:			
Fasteners tight	Q		
Cover panels secure	Q		
Welds	A		

	Q/A	Y/N/O	R
WHEELS:			
Tire damage	Q		
Lug nuts (Wheel mounting) torqued correctly	Q		
King Pins lubed	A		
COMPONENT AREA:			
Hydraulic - no leaks	Q		
Hydraulic tank, correct level	Q		
Hoses not damaged - Fittings tight	Q		
Valve manifold secure, no leaks	Q		
Power unit secure, no leaks	Q		
Batteries properly filled and cables clean	Q		
Emergency stop, cuts power/operation	Q		
Battery switch cuts battery feed	Q		
Plastic cover secure (door end 2632-4555 only)	A		
Hydraulic tank, oil clean	A		
Replace Hydraulic Filter (if equipped)	A		
Clean or replace tank breather filter	A		
OPERATIONAL INSPECTION:			
All functions, operate smooth and quiet	Q		
All functions, speeds correct.	Q		
Upper control box, operates correctly	Q		
Emergency Down, operates correctly	Q		
Limit switches slows drive when elevated	Q		
Pothole switch test	Q		
Steering pressure relief, set correctly	Q		
Lift pressure relief, set correctly	A		
**Check Platform Overload Sensing operation	A		

**For machine equipped with Platform Overload Protection system only



Decals

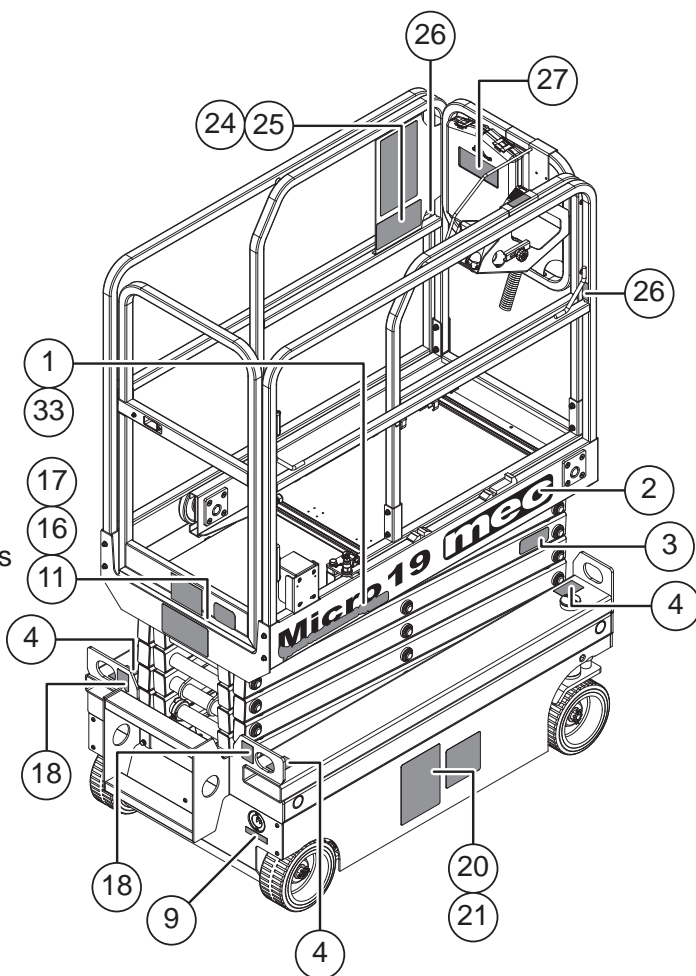
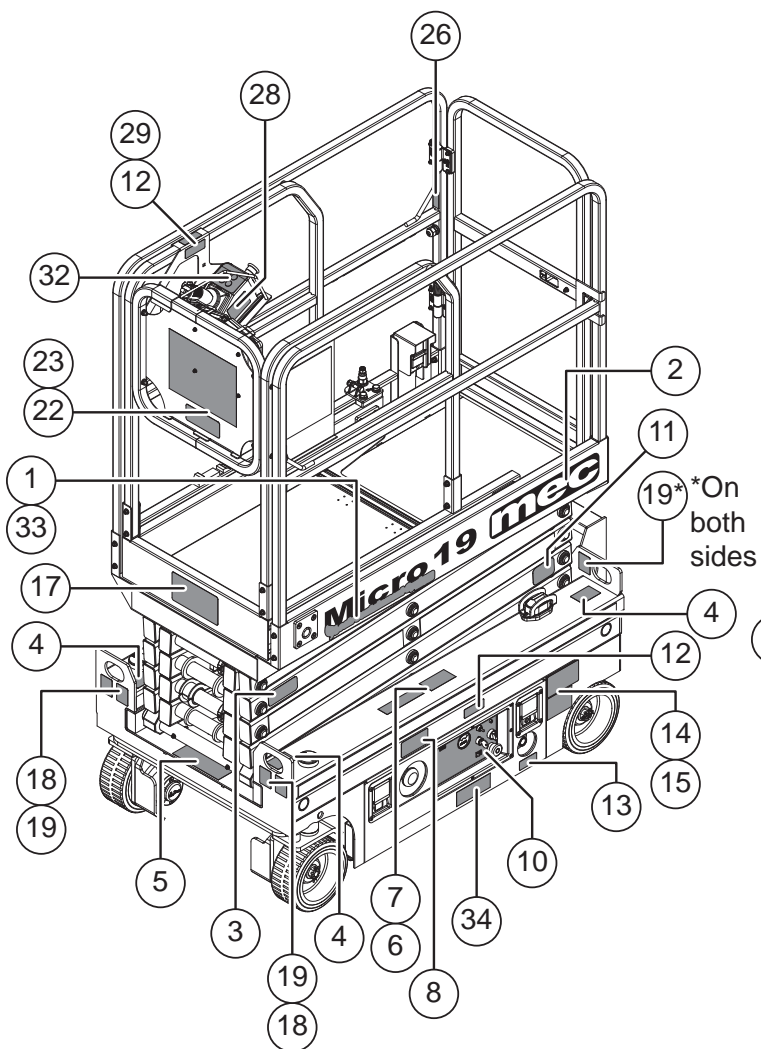



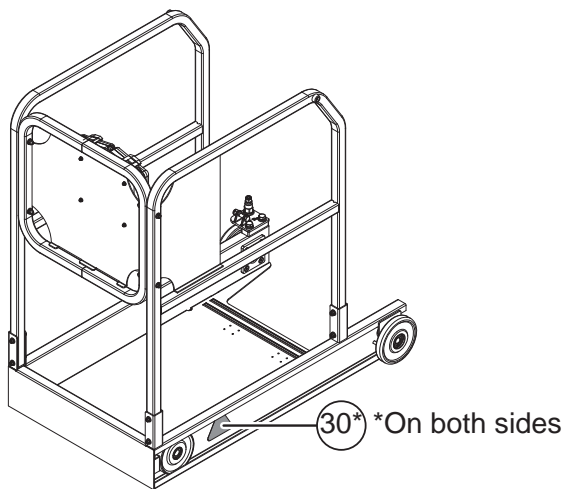



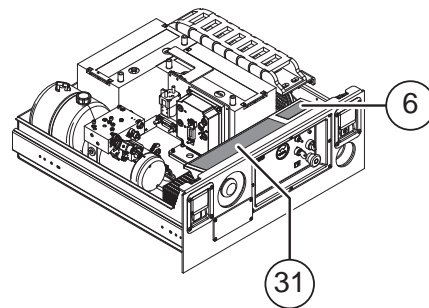

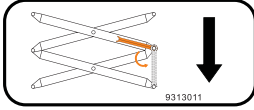

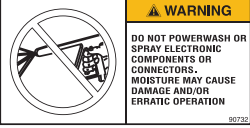

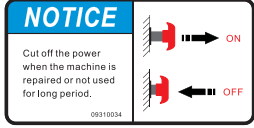



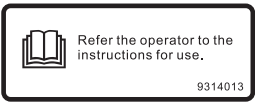

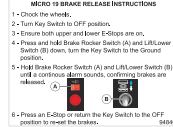

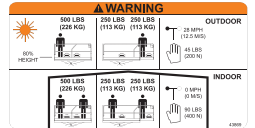







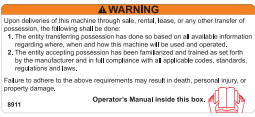

PLATFORM EXTENDED



CONTROL MODULE



<p>1</p> <p>Micro 19</p> <p>94559 Qty. - 2</p>	<p>2</p> <p>mec</p> <p>94114 Qty. - 2</p>	<p>3</p>  <p>9313011</p> <p>41638 Qty. - 2</p>	<p>4</p> <p>WARNING</p> <p>MAXIMUM TIE-DOWN ANGLE 30°</p>  <p>94362 Qty. - 4</p>	<p>5</p>  <p>95215 Qty. - 1</p>
<p>6</p>  <p>90732 Qty. - 2</p>	<p>7</p> <p>WARNING</p> <p>RELEASE BRAKES BEFORE TOWING TO PREVENT DAMAGE TO DRIVE SYSTEM</p>  <p>42534 Qty. - 1</p>	<p>8</p> <p>NOTICE</p> <p>Cut off the power when the machine is repaired or not used for long period.</p>  <p>9311004</p> <p>43910 Qty. - 1</p>	<p>9</p> <p>BATTERY CHARGER AND POWER TO PLATFORM</p>  <p>94659 Qty. - 1</p>	<p>10</p>  <p>44536 Qty. - 1</p>
<p>11</p>  <p>95254 Qty. - 2</p>	<p>12</p> <p>Refer the operator to the instructions for use.</p>  <p>9314013</p> <p>41639 Qty. - 2</p>	<p>13</p> <p>EMERGENCY LOWER</p> <p>Pull knob to lower platform</p>  <p>9311017</p> <p>41636 Qty. - 1</p>	<p>14</p> <p>WARNING</p> <p>Tip-over Hazard</p> <p>Do not use batteries that weigh less than the original equipment. Batteries are used as counterweight and are critical to machine stability. Each battery must weigh 72 lbs / 32.7 kg. The batteries must weigh a minimum of 144 lbs / 65.4 kg.</p>  <p>9411061UM</p> <p>42493 Qty. - 1</p>	<p>15</p> <p>MICRO 19 BRAKE RELEASE INSTRUCTIONS</p> <ol style="list-style-type: none"> 1 - Check the wheels. 2 - Turn Key Switch to OFF position. 3 - Ensure both upper and lower E-Clips are on. 4 - Press and hold Brake Rocker Switch (A) and L/R Lower Switch (B) down, turn the Key Switch to the "Source" position. 5 - Hold Brake Rocker Switch (A) and L/R Lower Switch (B) until a continuous alarm sounds, confirming brakes are released. 6 - Press an E-Clip or return the Key Switch to the OFF position to reset the brakes.  <p>94846 Qty. - 1</p>
<p>16</p>  <p>95301 Qty. - 1</p>	<p>17</p> <p>WARNING</p> <p>OUTDOOR</p> <p>500 LBS (226.8KG) 250 LBS (113.4KG) 250 LBS (113.4KG)</p> <p>20 MPH (12.24 M/S) 10 LBS (4.54 KG)</p> <p>INDOOR</p> <p>500 LBS (226.8KG) 250 LBS (113.4KG) 250 LBS (113.4KG)</p> <p>0 MPH (0 M/S) 10 LBS (4.54 KG)</p>  <p>43869 Qty. - 2</p>	<p>18</p>  <p>9311015</p> <p>41635 Qty. - 4</p>	<p>19</p>  <p>9311013</p> <p>41634 Qty. - 4</p>	<p>20</p> <p>WARNING</p>  <p>41649 Qty. - 1</p>
<p>21</p> <p>DANGER</p> <p>Explosion/Burn Hazard</p>  <p>41641 Qty. - 1</p>	<p>22</p> <p>mec DIRECT ELECTRIC DRIVE</p>  <p>94423 Qty. - 1</p>	<p>23</p>  <p>MEC AERIAL WORK PLATFORMS 1451 S. SANFORD AVE. IRVINE, CA 92614 USA 1-800-461-1000 www.MECap.com</p> <p>90719 Qty. - 1</p>	<p>24</p> <p>DANGER</p>  <p>43885 Qty. - 1</p>	<p>25</p> <p>DANGER</p> <p>Tip-over Hazard</p> <p>If a failure occurs, unit is in an unsafe state. Death or serious injury could occur.</p>  <p>41647 Qty. - 1</p>
<p>26</p> <p>Restraint only 1 Occurrence</p>  <p>9414123UM</p> <p>41648 Qty. - 3</p>	<p>27</p> <p>WARNING</p> <p>Upon delivery of this machine through sale, rental, lease, or any other transfer of possession, the following shall be done:</p> <ol style="list-style-type: none"> 1. The entity transferring possession has done so based on all available information regarding where, when and how this machine will be used and operated. 2. The entity accepting possession has been informed and trained on all tasks by the manufacturer and in full compliance with all applicable codes, standards, regulations and laws. <p>Failure to adhere to the above requirements may result in death, personal injury, or property damage.</p>  <p>8911 Operator's Manual inside this box.</p> <p>94114123UM</p> <p>8911 Qty. - 1</p>	<p>28</p> <p>DRIVE FORWARD/LOWER</p>  <p>94528 Qty. - 1</p>	<p>29</p> <p>Platform controller normal position.</p>  <p>9314015</p> <p>41640 Qty. - 1</p>	<p>30</p>  <p>91850 Qty. - 2</p>
<p>31</p>  <p>43879 Qty. - 1</p>	<p>32</p>  <p>41632 Qty. - 1</p>	<p>33</p> <p>Leak Containment System</p>  <p>94866 Qty. - 2</p>	<p>34</p> <p>Leak Containment System</p>  <p>94867 Qty. - 1</p>	

Serial Plate

Serial Plate Location

The serial plate is attached to the machine at the time of manufacture. Important information about the machine is recorded on the serial plate.

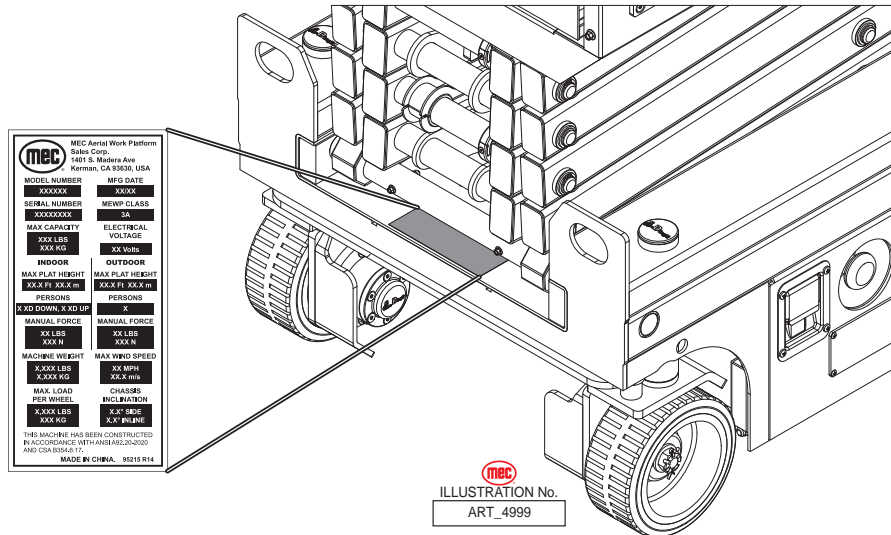

Serial Plate Description

MODEL NUMBER: Identifies the machine.

MFG DATE: Month / Year of manufacture.

SERIAL NUMBER: Identifies a machine with reference to its original owner. Refer to the number when requesting information or ordering parts.

MEWP CLASS: MEWP = Mobile Elevating Work Platform

MAX. CAPACITY: The maximum safe load (material, persons + equipment) which can be correctly placed on the platform at any elevation.

ELECTRICAL VOLTAGE: The voltage at which this machine operates.

MAX. PLATFORM HEIGHT (INDOOR): The indoors maximum attainable height measured from level ground surface to platform floor.

PERSONS (INDOOR): The maximum number of occupants indoors.

MANUAL FORCE (INDOOR): Amount of manual force need to move machine indoors.

MAX. PLATFORM HEIGHT (OUTDOOR): The outdoors maximum attainable height measured from level ground surface to platform floor.

PERSONS (OUTDOOR): The maximum number of occupants outdoors.

MANUAL FORCE (OUTDOOR): Amount of manual force need to move machine outdoors.

MACHINE WEIGHT: The weight of the machine with no options.

MAX WIND SPEED: The maximum wind speed for safe working conditions.

MAX. LOAD PER WHEEL: The maximum safe weight applied to each wheel. Calculated with all available options installed. $F_w = 30\% (W_m + W_c + W_{opt})$

CHASSIS INCLINATION: The maximum amount of tilt for safe working conditions.

Troubleshooting

Should you experience erratic operation or notice any malfunction while operating this machine, discontinue use immediately.



Call for assistance and report the incident to your supervisor, and do not use the machine until it has been checked by a trained, qualified mechanic.

Machine functions will not operate

- Master disconnect turned on?
- Batteries properly connected?
- Batteries fully charged?
- Key Switch in proper position?
- Both Emergency Stop Switches reset?
- Function Enable Switch not activated?
- Hydraulic fluid level low?
- Obvious fluid leak or damaged component?
- Wires disconnected, broken, or loose?
- Diagnostic panel on?
- Platform Control Box Fault Code present?
 - Contact MEC Technical Support or refer to service manual. Manuals are available free online at www.MECawp.com.

Transport and Lifting Instructions

Safety Information

This section is provided for reference and does not supersede any government or company policy regarding the loading, transport or lifting of MEC machinery.

Truck drivers are responsible for loading and securing machines, and should be properly trained and authorized to operate MEC machinery. Drivers are also responsible for selecting the correct and appropriate trailer according to government regulations and company policy. Drivers must ensure that the vehicle and chains are strong enough to hold the weight of the machine (see the serial number plate for machine weight).



While loading and unloading, the transport vehicle must be parked on a level surface and secured to prevent rolling.

Loading: Free-wheel configuration for Winching or Towing

RUNAWAY HAZARD!



After releasing the brakes there is nothing to stop machine travel. Machine will roll freely on slopes.

ALWAYS chock the wheels before manually releasing the brakes.

The machine can be winched or towed short distances at speeds not to exceed 2.5mph (4km/h). Before towing or winching the machine, it is necessary to release the brakes. Reset the brakes after towing or winching.

Disengage Brakes Before Towing Or Winching

1. Chock the wheels.
2. Turn the Key Switch to the Off position.
3. Pull the Red Emergency Stop button out to the On position (pulled out) at both the ground and platform controls.
4. At the ground controls, push the Brake Release Switch to the left and hold the Lift/Lower Switch to the lower position.
5. Turn the Key Switch to the left to the Ground position. An alarm will sound, signaling that the brakes are released.

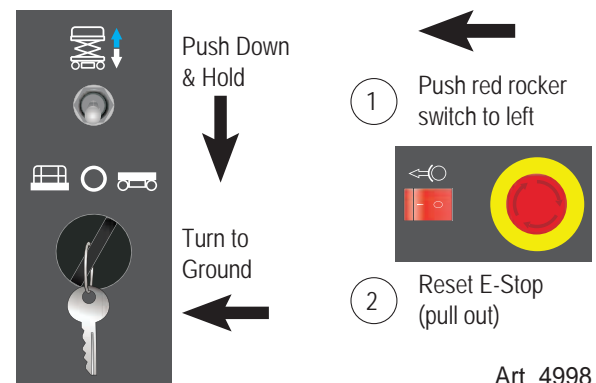

Resetting Brakes

Push in the Emergency Stop button or turn the Key Switch to the Off position to reset the brakes.

Driving or Winching onto or off of a Transport Vehicle



Always attach the machine to a winch when loading or unloading from a truck or trailer by driving.

Read and understand all safety, control, and operating information found on the machine and in this manual before operating the machine.

Before loading or unloading the machine, check that:

- The deck extension, controls and component trays are secure.
- The platform is fully lowered.
- All loose items have been removed.

Before driving or winching the machine:

- Attach the machine to a winch.
- Remove all machine tie downs. Remove wheel chocks.

Driving

- Turn the Base Key Switch to Platform. Check that the Emergency Stop button is reset by pulling the button out to the On position (pulled out).
- Enter the platform and reset the Platform Emergency Stop Switch.
- Test platform control functions.
- Select slow drive speed mode. Carefully drive the machine off the transport vehicle with the winch attached.

Note: The brakes are automatically released for driving and will automatically apply when the machine stops.

Winching

- Disengage brakes (see Free-wheel configuration for Winching or Towing on page 37).
- Carefully operate the winch to lower the machine down the ramp.
- Chock the wheels and engage the brakes.



Lifting the machine from the side may result in component damage.

Lifting the machine with a Forklift

- Position the forklift forks in line with the forklift pockets.
- Drive forward to the full extent of the forks.
- Raise the machine 6 inches (15 centimeters) and then tilt the forks back slightly to keep the machine secure.
- Be sure the machine is level when lowering the forks.

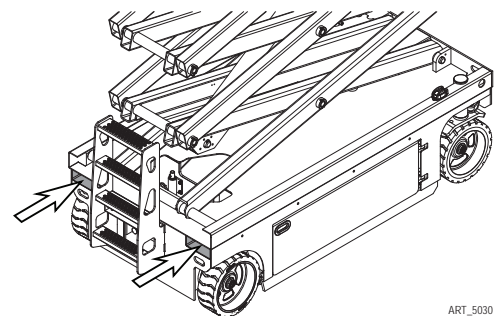

ART_5030

**CAUTION**

Ensure that angle of each hold-down chain or strap does not exceed 30° relative to the trailer deck.

Securing to truck or trailer for Transport

- Turn the Key Switch to off and remove the key before transport.
- Inspect the entire machine for loose or unsecured items.
- Chock the wheels
- Use the tie-down points on the chassis for anchoring down to the transport surface.
- Use chains or straps of ample load capacity.
- Use a minimum of four (4) chains or straps.
- Adjust the rigging to prevent damage to the chains and the machine.

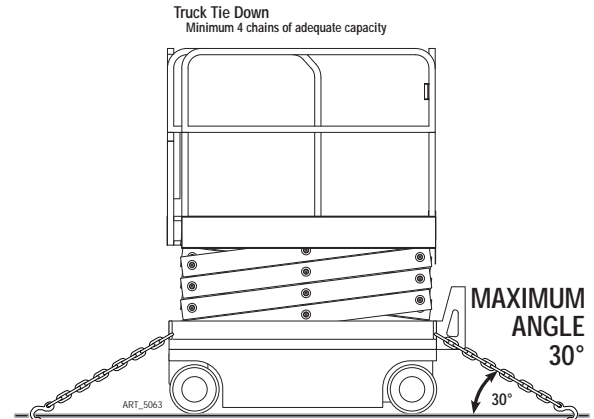

Lifting Instructions

Only qualified riggers should rig and lift the machine.

**WARNING**

Ensure that the crane, loading surfaces, spreader bars, cables, chains and straps are of sufficient capacity to withstand the machine weight. See the serial plate for the machine weight.

- Fully lower the platform. Be sure the deck extension is retracted and the controls and component trays are closed and secure. Remove all loose items from the machine.
- Determine the center of gravity of the machine.
- Attach rigging to the designated lift points only.
- Adjust the rigging to prevent damage to the machine and to keep the machine level.

Notes

Notes

Notes



Limited Owner Warranty

MEC Aerial Platform Sales Corp. warrants its equipment to the original purchaser against defects in material and/or workmanship under normal use and service for one (1) year from date of registered sale or date the unit left the factory if not registered. MEC Aerial Platform Sales Corp. further warrants the structural weldments of the main frame and scissor arms to be free from defects in material or workmanship for five (5) years from date of registered sale or date unit left the factory if not registered. Excluded from such warranty is the battery(s) which carries a ninety (90) day warranty from described purchase date. Warranty claims within such warranty period shall be limited to repair or replacement, MEC Aerial Platform Sales Corp's option, of the defective part in question and labor to perform the necessary repair or replacement based on MEC Aerial Platform Sales Corp's then current flat rate, provided the defective part in question is shipped prepaid to MEC Aerial Platform Sales Corp. and is found upon inspection by MEC Aerial Platform Sales Corp. to be defective in material and/or workmanship. MEC Aerial Platform Sales Corp. shall not be liable for any consequential, incidental or contingent damages whatsoever. Use of other than factory authorized parts; misuse, improper maintenance, or modification of the equipment voids this warranty. The foregoing warranty is exclusive and in lieu of all other warranties, express or implied. All such other warranties, including implied warranties of merchantability and of fitness for a particular purpose, are hereby excluded. No Dealer, Sales Representative, or other person purporting to act on behalf of MEC Aerial Platform Sales Corp. is authorized to alter the terms of this warranty, or in any manner assume on behalf of MEC Aerial Platform Sales Corp. any liability or obligation which exceeds MEC Aerial Platform Sales Corp's obligations under this warranty.



MEC Aerial Work Platforms

1401 S. Madera Avenue, Kerman, CA 93630 USA

Toll Free: 1-877-632-5438

Phone: 1-559-842-1500

Fax: 1-559-842-1520

info@MECawp.com

www.MECawp.com